

Objectives

Last time we considered the ventral visual stream; today, we will focus on the visuospatial aspects of processing carried out by the dorsal stream. We will consider how the techniques and findings of cognitive neuroscience can be used to investigate the psychological nature and neural basis of neurological syndromes such as neglect. We will also consider different kinds of spatial processing, and how they might be mediated by the parietal cortex. Armed with this background, we will consider Goodale & Milner's (1992) visual streams hypothesis.

Anatomy, electrophysiology, and functional imaging of the dorsal stream

Last lecture, we mentioned distinctions between the processing pathways arising from M and P retinal ganglion cells. Much useful information about visual motion derives from M-type retinal ganglion cells, which have high contrast sensitivity, transient responses, and little wavelength selectivity. They project via the magnocellular layer of the LGN, V1, and V2, to area **V5** (also known as **MT** in the monkey). This is sometimes referred to as the *magnocellular-dominated stream*. However, we should note at this point that there is not a simple correspondence between the tuning of neurons to lower-level dimensions (such as the P versus M distinction) and higher-level visual processing. Information from P and M systems contributes in several ways to both dorsal and ventral streams, even if the M system dominates in the dorsal stream (see figures below).

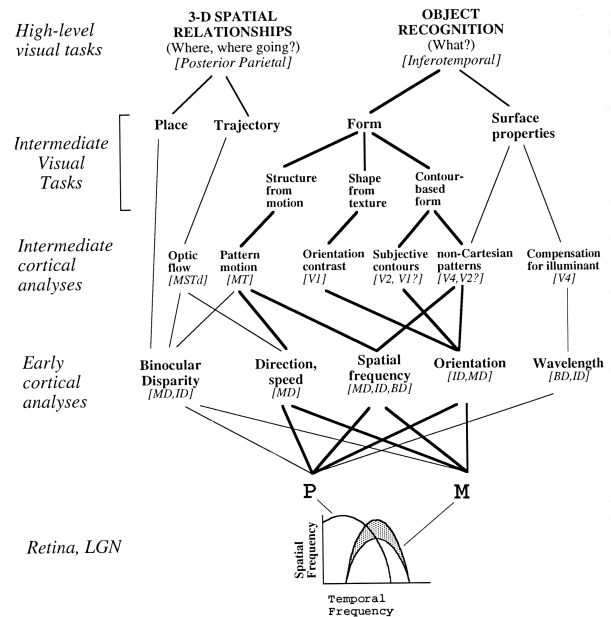
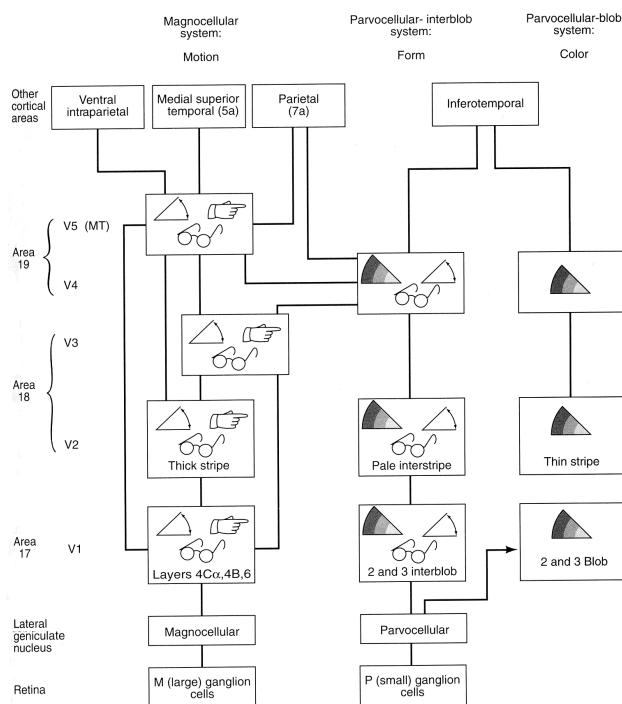

Two views of convergence and divergence in visual processing streams (MD magnocellular-dominated; ID interblob-dominated; BD blob-dominated). It remains true that the dorsal stream is magnocellular-dominated (as suggested by the left-hand figure, from last week's handout), but that is not to say that the P-type retinal ganglion cells do not contribute to the dorsal stream at all. **Left** based on DeYoe & van Essen (1988); **right** from van Essen & DeYoe (1995).

In MT, neurons appear to respond quite selectively to movement and stereoscopic depth. Excitotoxic lesions of MT impair monkeys' ability to saccade to a moving, but not a stationary target (Newsome *et al.*, 1985), stimulation of MT alters motion perception (Salzman *et al.*, 1990; see Cohen & Newsome, 2004), and a patient has been discovered who has a fairly discrete deficit in visual motion perception, or *akinetopsia*, following damage to V5 (Zihl *et al.*, 1983; Shipp *et al.*, 1994). As we dis-

cussed in the last lecture, functional imaging studies have shown that V5 is consistently activated by visual motion (e.g. Zeki *et al.*, 1991).

Area MT also projects to another area in the superior temporal lobe, named **V5a** (or **MST** in the monkey), and from here anteriorly to the **frontal eye fields (FEF)** in the frontal lobes, which are concerned with voluntary eye movements. The other major projections of MST are to **area 7 (or PG)** in the posterior parietal cortex. You may recall from the last lecture that lesions of posterior parietal cortex (including PG) led to impairments when monkeys were required to discriminate objects on the basis of their spatial location (Pohl, 1973; Mishkin *et al.*, 1982) — experiments that led to this region being defined as part of the dorsal stream.

Blindsight and the dorsal stream

The intriguing clinical syndrome of ‘blindsight’ follows removal of striate cortex (V1). It had been noted in the early 20th century that patients with striate cortex damage could sometimes perceive movement in parts of the visual field in which they were otherwise blind (in their *scotomata*) (Bard, 1905; Riddoch, 1917); colour perception has also been observed in the absence of other visual abilities (see Stoerig & Cowey, 1997). In the 1960s and 1970s striate cortex removal was observed to leave residual visual abilities in monkeys (Cowey & Weiskrantz, 1963; Humphrey, 1974). Famously, the monkey Helen was still able to reach out in space for morsels of food despite the lesion (Humphrey, 1974). These observations were paralleled by similar findings in humans (e.g. Pöppel *et al.*, 1973). For example, patient D.B. was subjectively blind, yet could reach out to locate a stimulus in space when asked to guess. Such patients are often bemused that the experimenter wishes them to locate a stimulus — after all, they are blind — yet when they do guess, they guess above chance performance (and are very surprised when informed of this). This phenomenon was termed ‘blindsight’ (Sanders *et al.*, 1974; Weiskrantz *et al.*, 1974).

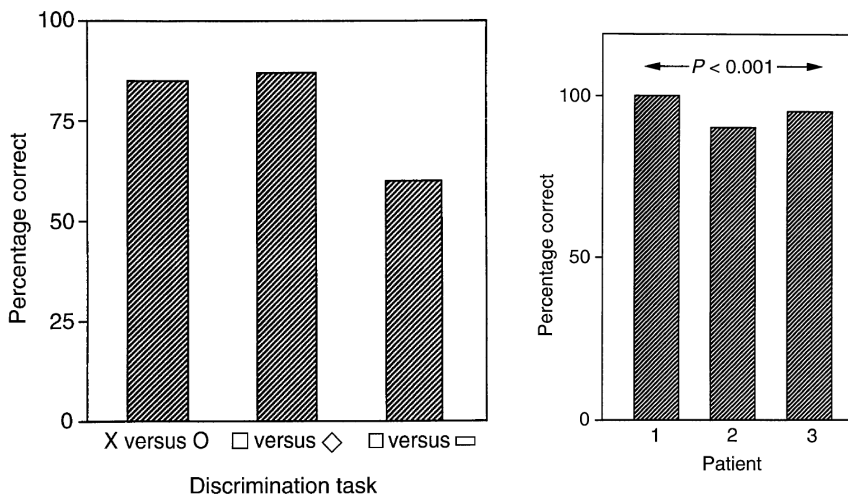

Blindsight. Left: shape discrimination (Weiskrantz, 1986). Right: discrimination the direction of motion of moving stripes (Perenin, 1991). Chance is at 50% in each case.

How does this operate neurally? It is notable that the dorsal stream retains much greater responsiveness to visual stimulation following V1 lesions than does the ventral stream (see Stoerig & Cowey, 1997). In humans, motion discrimination persists following striate cortex lesions, but is abolished by hemidecortication (Perenin, 1991). PET studies have shown V5 activation by moving visual stimuli (with, in this case, conscious perception of motion) despite V1 lesions (Barbur *et al.*, 1993). These and similar results indicate that extrastriate cortex is responsible for much of the persistent visual ability. Although subsets of retinal ganglion cells degenerate (transneuronal retrograde degeneration) following striate cortex lesions, information from the retina can reach extrastriate areas of cortex — either via the LGN and the pulvinar, which receive direct retinal input, or via more circuitous pathways. Many of these involve the superior colliculus, lesions of which can sometimes abolish V5 neuronal responses to motion when V1 lesions did not. The superior colliculus is part of the tectum (the ‘roof’ of the midbrain) and is responsible for animals’ natural orienting response to visual stimuli (Schneider, 1969).

The phenomenon of blindsight has engendered much interest as evidence that may speak to the neural basis of conscious experience (e.g. Zeki, 1993; Baars, 1998; Güzeldele *et al.*, 2000), particularly as the information mediated by the dorsal stream does not often appear accessible to consciousness. Finally, there may be a similar condition of 'deaf hearing' (Garde & Cowey, 2000).

Bálint's syndrome, neglect, and the parietal cortex

Right-sided parietal lesions in humans often lead to spatial and visuomotor difficulties such as *constructional apraxia* (problems with drawing and copying), whereas left-sided lesions produce *limb apraxia* (impairments in gesturing, posturing, etc., to command). **Bálint's syndrome** is the triad of *optic ataxia* (impaired visually-guided limb movement, i.e. misreaching), *simultanagnosia* ('psychic gaze paralysis': inability to attend to more than one object at a time), and a left-sided *hemispatial neglect* (the deviation of attention to the right-hand side of space) (Bálint, 1909).

Much more common than complete Bálint's syndrome is isolated **hemisensory neglect**. This is readily observed in the visual modality. Patients ignore the contralateral side of space, demonstrable by tests such as line bisection and copying a drawing (see Cognitive Neuropsychology lectures). It is common for neglect to recover somewhat, at which time a phenomenon termed *extinction* can be demonstrated (not to be confused with the learning theory use of the term!): patients can see objects on their left and their right, but if the two objects are presented simultaneously, they only report the one on their right. Neglect of the left-hand side of space, which follows lesions of the right inferior parietal lobule (areas 39 and 40), is more common and/or more severe than neglect of the right-hand side of space. This is surprising. Maybe the right hemisphere processes information from (or shifts attention away from) left and right spatial locations, while the left hemisphere only processes information from the right-hand side of space (or shifts attention away from the left-hand side; see next lecture). Another part of the explanation may be that the right parietal cortex is specialized for *global* spatial processing, making dysfunction obvious, while left parietal cortex is specialized for *local* processing, such as of sub-parts of objects (see Robertson & Rafal, 2000 for interesting examples).

Neglect is clearly a complex problem involving attention as well as spatial representation. For example, Italian patients with neglect were asked to describe, from memory, the famous Piazza del Duomo in Milan. Their description omitted all the buildings on the left-hand side of space. However, if they were asked to imagine the scene as if they were now standing on the opposite side of the square, they now neglected the buildings on their *new* left, but reported the previously-omitted buildings (Bisiach & Luzzatti, 1978). Neglect is often *object-centred* (e.g. patients neglect the left-hand side of an object even if the whole object is presented in the right-hand side of space). Patients also fail to report detail on the left half of an object when they must form a mental representation of the object by viewing it through a vertical slit, one part at a time (Bisiach *et al.*, 1979; Ogden, 1985).

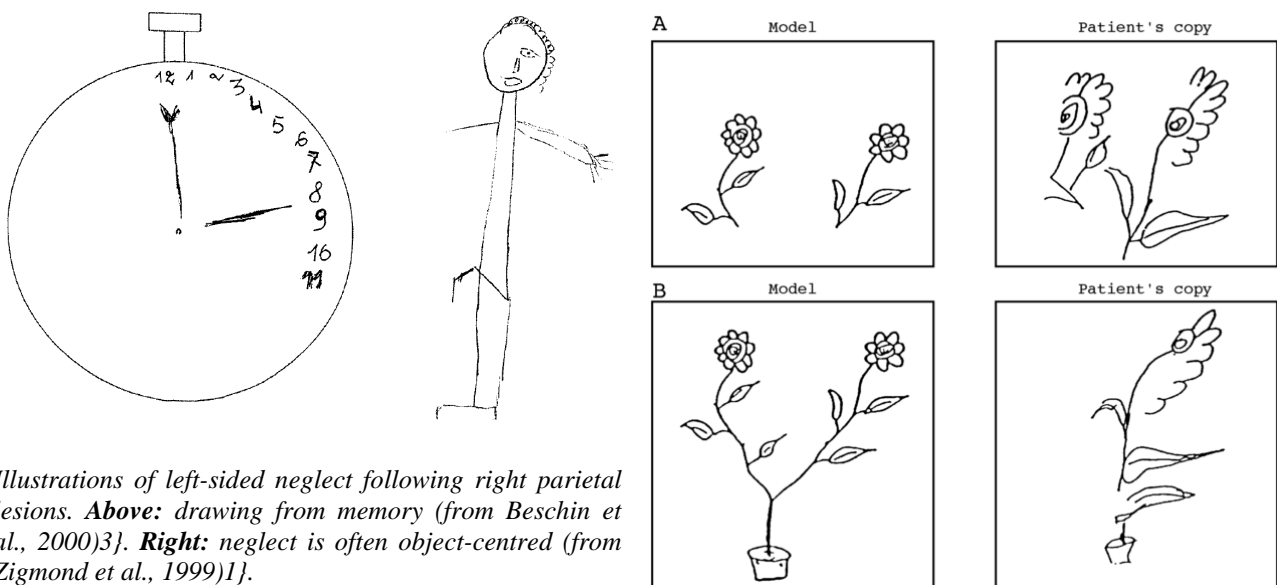

Illustrations of left-sided neglect following right parietal lesions. **Above:** drawing from memory (from Beschin *et al.*, 2000)3}. **Right:** neglect is often object-centred (from Zigmund *et al.*, 1999)1}.

Neglect is frequently polysensory, with similar problems in the tactile and auditory modalities. Posterior parietal cortex (specifically, area 5) lesions also induce complex somatosensory impairments, particularly *astereognosis* (or *tactile agnosia*: an inability to recognize objects by touch) and *amorphosynthesis* (impairment of body image). In general, lesions of more anterior/superior regions of this area of superior parietal cortex (area 5) have a greater impact on somatosensory spatial processing than lesions of more posterior/inferior regions (area 7), which affect visuospatial cognition more.

Spatial frames of reference

Before proceeding further, we need to define some terms commonly used to describe different spatial frames of reference (Behrmann, 2000). Our perception and movements are governed by a number of different frames of reference: we possess retinotopic, somatotopic, and tonotopic maps of sensory environments; these must be related to each other and to proprioceptive and motor information about our eye, head, and limb position. How are these maps matched up? There are obvious difficulties given that the maps are spatially distorted (e.g. the size of somatosensory representations in somatosensory cortex depend on skin receptor density rather than the physical size of the represented area), the receptors are constantly moving, and the coordinate systems for these maps are very different.

One solution would be to translate these into a common system of **egocentric** space that took account of different magnifications and distortions in sensory maps, and compensated for the constant movement of sensory receptors. One obvious egocentric reference point is the body's midline (the only way we can define left and right). However, even this reference point may be different for the eyes, the head, and the body axis as they move relative to each other.

The relationship of objects to one another in space does not depend on our body orientation to them; this kind of mapping is termed **allocentric**. Patients with neglect exhibit some egocentric deficits, but it is not clear that object-centred deficits can be explained in egocentric terms.

Another distinction sometimes made is between the space occupied by our body (*personal space*), the space within which we can reach out and touch objects (*peripersonal space*), and space beyond this (*extrapersonal space*).

Anatomy of the posterior parietal cortex

The posterior parietal cortex can be divided into the superior and inferior parietal lobules, separated by the intraparietal sulcus (see figure, noting fairly substantial species differences). In humans, the superior parietal lobule comprises areas 5, 7a, and 7b. The inferior parietal lobule comprises areas 39 (the angular gyrus) and 40 (the supramarginal gyrus) in humans; there are no obvious homologues to these regions in monkeys. Buried in the intraparietal sulcus are several regions including the anterior, lateral, medial, and ventral intraparietal areas (AIP, LIP, MIP, VIP).

Retrograde tracing studies in monkeys using horseradish peroxidase (HRP) labelling have shown that posterior parietal cortex (area PG) receives input from a limited set of cortical regions including prefrontal cortex, the intraparietal and superior temporal sulci, medial parietal cortex, and cingulate cortex. These areas are polymodal. Area PG therefore receives highly processed information, which converges with influences from the limbic system (i.e. cingulate cortex) and reticular formation (e.g. noradrenaline and acetylcholine neuromodulation).

The parietal cortex is a candidate structure for the purpose of representing egocentric space, and using information about spatial relationships to guide and sequence movements. It is multimodal, receiving visual, auditory, somatosensory, and proprioceptive/movement-related information — including vestibular signals and information about eye position and neck movements. Area 5 reciprocally connects somatosensory with limbic and motor structures, whereas area 7 does the same for visual, auditory, and somatosensory input. The parietal cortex has strong connec-

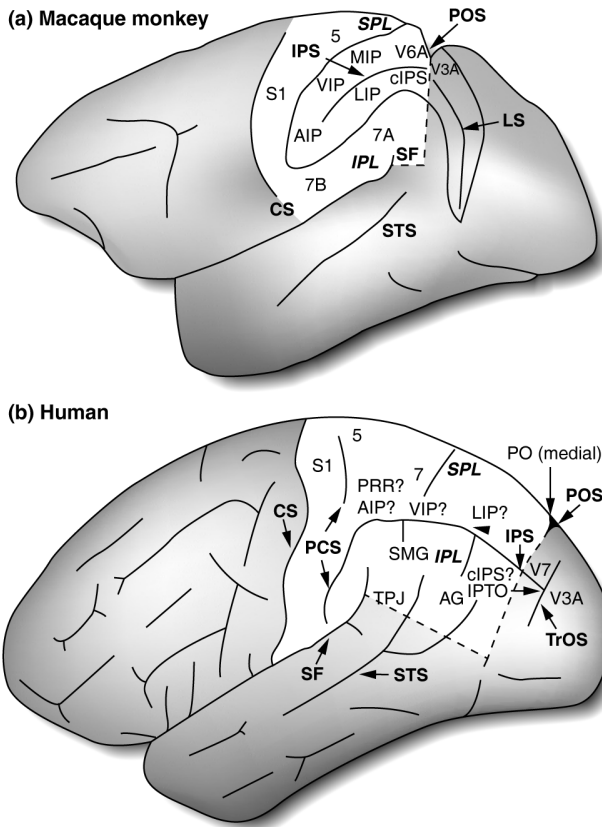

Parietal cortex in monkeys and humans, from Culham & Kanwisher (2001).

Boundaries of whole lobes: CS, central sulcus [divides frontal and parietal lobes]; SF, Sylvian fissure [or lateral fissure; divides temporal from frontal/parietal lobes]; POS, parieto-occipital sulcus.

The intraparietal sulcus (IPS) divides the parietal lobe into the superior parietal lobule (SPL) and inferior parietal lobule (IPL).

In the monkey, parietal cortex contains S1 (somatosensory cortex), Brodmann's areas 5, 7a, and 7b; visual areas V3A (occipitoparietal boundary) and V6A; and the anterior (AIP), ventral (VIP), medial (MIP), lateral (LIP), and caudal (cIPS) sections of the IPS. In the picture, the IPS has been opened up to show the regions within it.

In the human, the SPL is probably homologous to the monkey IPL. Regions suspected to be homologues to monkey regions are marked. Additionally, there are areas with no obvious homologue: V7, the supramarginal (SMG) and angular (AG) gyri; functional area IPTO at the IPS/transverse occipital sulcus (TrOS) or 'parieto-temporo-occipital' (PTO) junction; the temporoparietal junction (TPJ), and the parieto-occipital (PO) region (PO). STS, superior temporal sulcus.

tions with the basal ganglia, the cerebellum (via the pons), and the superior colliculus (which has important functions in *orienting* to novel or significant stimuli, especially involving head and eye movements). Finally, areas 5 and 7 have strong, reciprocated projections to the frontal lobes.

Electrophysiology of the posterior parietal cortex

Parietal cortex electrophysiology is complex, so we will merely look at some interesting examples of neuronal responses in this area, in order to establish the kind of spatial information that is being processed here.

Area cIPS — complex spatial information, such as 3D surface orientation

The caudal intraparietal sulcus (cIPS in the figure above), part of the dorsal visual stream, is involved in the processing of 3D spatial information. The retinal image is two-dimensional, yet the brain reconstructs a 3D world using this information. This is not merely due to binocular disparity (stereopsis); there is a wealth of 3D information in a single image. Some neurons in cIPS respond to the orientation of surfaces in space, whether that orientation is defined by stereopsis (tested using random-dot stereograms a bit like those you can buy in coffee-table books) or texture gradient patterns (Tsutsui *et al.*, 2002). So the cIPS has some of the necessary ingredients for creating a 3D representation of space. What else can we find?

Area LIP — an 'eye-centred' representation of visual space: retinotopicity with sophistication

Neurons in area LIP exhibit many kinds of task-related activities (e.g. Mountcastle *et al.*, 1975; see Colby & Olson, 1999). They respond to *visual stimuli*, having fairly large receptive fields. They exhibit marked *attentional* effects (an increase in response when the monkey is attending to the stimulus; see next lecture). They may continue to fire to *remembered* visual stimuli even when the physical stimulus has vanished. Their firing may depend on the *position of the eye* in the orbit — for example, firing more when a monkey is looking towards the left-hand side of a screen. This implies that their involvement in spatial representation is more than a simple retinotopic map — and this is a vital part of maintaining a representation of visual space, since every object in the world moves to a different location on the retina

when we move our eyes. Neurons in LIP also have motor properties: they may fire just before a *saccade* that will move the fovea to the neuron's receptive field. LIP projects to the superior colliculus and the frontal eye fields, both of which are involved in generating eye movements.

Let's look at the spatial properties of these neurons in more detail. Approximately 20% of LIP neurons fire and maintain their firing after the subject has initiated a saccade to a briefly-presented visual target, but before the saccade is completed, and after the target has been turned off (C in the figure below) (Duhamel *et al.*, 1992a). This suggests that the neurons are encoding the updating or shifting of an internal image of a stable visual world (i.e. that the memory trace of a previous visual event is shifted in LIP during an eye movement, to match the *new* position of the eyes). This is a retinal map, but it does more than simply respond to retinal input. The updating appears to be a result of *efference copy* ('corollary discharge') information about the saccade: the updating is too fast to be a response to proprioceptive feedback (anyway, proprioceptive feedback is minimal or non-existent for eye movements). (A quick aside: the use of efference copy information explains why the world does not appear to move when you move your eyes normally and rapidly, but it does if you close one eye and lightly tap the side of the other eyeball — when there is no efference copy.)

A working hypothesis is that as a result of efference copy indicating that a saccade is about to begin, active neurons in LIP transmit their information about the stimulus to new neurons whose receptive fields will contain the stimulus after the saccade. The implication is that the representation of visual space is made stable in the face of rapid eye movements (cf. Bridgeman, 1994). Patients with parietal lesions are impaired at a rapid two-step saccade task, perhaps because they cannot use efference copy information from the first saccade to plan the direction of the second (Duhamel *et al.*, 1992b).

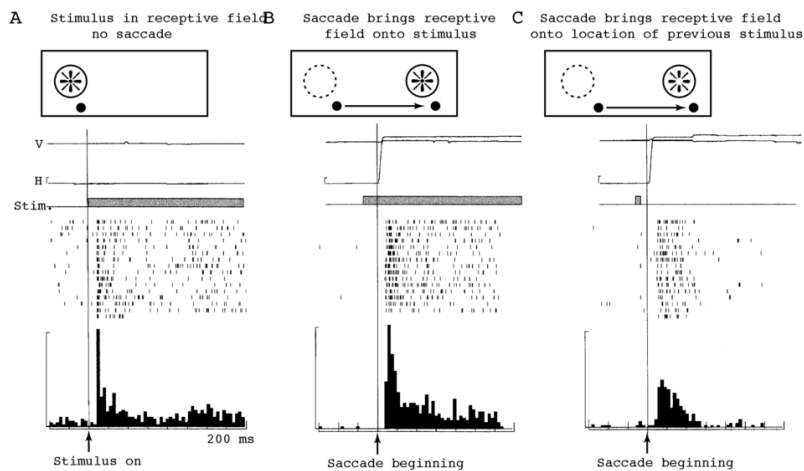

*Peri-stimulus time histograms of a LIP neuron's activity (stim = stimulus; H = horizontal eye position) (Duhamel *et al.*, 1992a). (A) Response to stimulus in receptive field (RF). (B) Response following the onset of a saccade that will bring the stimulus into the RF. (C) Response following the onset of a saccade that would have brought the stimulus into the RF, were it still physically present! The stimulus is presented and triggers a saccade, but the stimulus is turned off before the eye actually moves. Nevertheless, the neuron responds — to a stimulus that never physically appears in its RF.*

Area VIP — a 'head-centred' representation of space

In VIP, adjacent to LIP, we find that neurons encode a 'head-centred' representation of space. These neurons respond strongly to moving stimuli, and are selective for stimulus speed and direction (much like other dorsal stream areas, such as MT/V5 and MST/V5a). Many of these neurons also respond to touch on the head and face, with somatosensory receptive fields that match their visual RFs (Duhamel *et al.*, 1991). For example, a neuron that responds to visual stimuli in the upper left visual field also responds when the left brow is touched. Movement direction is also matched across the two modalities: for example, a neuron that responds to a visual stimulus moving right might also respond to a gentle touch moving right across the face. Furthermore, when the eyes move, the receptive fields move relative to the retina — that is, they are not retinotopic, but head-centred. It is not too surprising that area VIP projects to regions of the premotor cortex involved in generating head movements.

In order to relate head-centred coordinates to allocentric ('world-centred') coordinates, one must also integrate information about head position (vestibular, proprioceptive, and efference copy). It appears that these interactions occur, with proprioceptive information modulating LIP activity and vestibular information modulating 7a activity (Snyder *et al.*, 1998).

Area 7a and 7b — a visuomotor interface

Area 7a neurons share many features with LIP neurons. Many area 7a neurons respond to the position of the eye in the orbit, even in a dark room. Some neurons respond best when monkeys fixate stimuli of interest; these properties are combined so that neurons respond best to a stimulus in their receptive field when the eye is in a certain position. Area 7a neurons also show saccade- and pursuit-related activity (Bremmer *et al.*, 1997), and area 7a projects to the hippocampus (implicated in aspects of spatial processing; see later lecture).

Although visually driven, area 7a also exhibits strong motor-related effects. This region contains 'arm projection' neurons that respond to visual targets, increase their responding as an arm is projected (moved!) towards it, and subside again when the target is reached. This is clearly relevant to the optic ataxia seen in Bálint's syndrome. There are also 'manipulation' neurons that fire when the target object is manipulated. Mountcastle *et al.* (1975) concluded that these neurons represent a 'command system for the manual exploration of extrapersonal space', i.e. a visual-motor interface.

While LIP and area 7a are predominantly visual, area 7b contains both visual and somatosensory neurons; many respond to both modalities.

Area AIP — visual guidance of precise hand movements

Neurons especially concerned with hand movements are found in area AIP, which is connected to a 'hand' region of the premotor cortex. These neurons are especially active when grasping objects, and appear to receive information from other regions of the parietal lobe about the three-dimensional features of the object, enabling them to guide hand movements (Gallese *et al.*, 1994; Murata *et al.*, 1996) (reviewed by Sakata *et al.*, 1997). Unlike premotor cortex neurons, they remain active during all of the various segments of the grasping sequence (such as the precision grip, whole-hand prehension and wrist rotation), suggesting some role in planning the entire action.

Area 5 — active touch?

Continuing towards somatosensory cortex, area 5 is predominantly responsive to somatosensory and proprioceptive input. It contains more complex representations than S1 (primary somatosensory cortex — meaning areas 3, 1, and parts of 2); for example, some neurons fire when animals actively reach for objects (but not on passive visual or cutaneous stimulation).

Summary

There appear to be multiple spatial reference frames represented within the parietal cortex, optimized for controlling different types of movement, rather than a single topographic representation of space. Note (for future discussion on attention and the parietal cortex) that many of the movements influenced by parietal cortex are involved in the direction of attention (i.e. eye and head movements).

Goodale & Milner's (1992) hypothesis of the two visual streams: 'what' versus 'how'

Now we have examined the multiple representations in parietal cortex, we are better placed to analyse a different hypothesis of the two visual streams. Goodale & Milner (1992) place less emphasis on sensory analysis of visual input (object location versus qualities, i.e. what *v.* where) — instead, they emphasize the use to which this in-

formation is put. They argue that the dorsal stream is specialized for the *visual guidance of action* (*visuomotor control*), rather than spatial perception/cognition *per se*.

Dorsal stream

Goodale and Milner point out that patients with optic ataxia following posterior parietal damage have deficits not only in reaching in the right direction, but also in positioning their fingers and orienting their hand when reaching towards an object that can be oriented at different angles (Perenin & Vighetto, 1988). They may also have trouble adjusting their grasp to reflect the size of the object. For example, when one patient (A.T.) who was recovering from Bálint's syndrome reached out for small objects, she failed to adjust the position of her index finger and thumb to the size, shape, and orientation of the object. *However*, she could recognize and describe objects using exactly this information about size, shape, and orientation, and could indicate the size of objects with her fingers (Jakobson *et al.*, 1991; Jeannerod *et al.*, 1994). This indicates that the use to which this (spatial) information is put is crucial in determining the effects of the lesion. (It is of some interest that patient A.T. could overcome some of her reaching deficit by the use of semantic information, e.g. she could pre-shape her hand to use highly familiar objects.)

Furthermore, there is evidence that parietal cortex damage does not induce a simple spatial deficit. Another patient with posterior parietal cortex damage was impaired on a task in which he had to use a visual image of a maze to guide a hand-held stylus through it; however, he was unimpaired when he had to move his whole body through space based on a similar visual plan (Newcombe *et al.*, 1987), and could perform other spatial tasks. This implies that he had problems with visually-guided arm movements, but that he did not have a general spatial impairment. Finally, the original 'landmark' deficits originally noted following posterior parietal lesions in monkeys (impairments in discriminating objects based on their spatial location: see previous lecture; Pohl, 1973; Mishkin *et al.*, 1982) may be due to a failure to attend or orient to the stimuli, rather than a failure to localize them (Milner *et al.*, 1977; Lawler & Cowey, 1987; Milner & Goodale, 1993).

Goodale & Milner's (1992) hypothesis fits well with the electrophysiological properties of parietal cortex (see above) — such as 'visuomotor' responses in parietal areas such as 7a and AIP. Consistent with this, temporary inactivation of AIP with the GABA_A receptor agonist muscimol impairs monkeys' ability to pre-shape their hand to pick up objects, without affecting their reaching ability (Gallese *et al.*, 1994).

Ventral stream

In contrast, patients with *visual agnosia* (Benson & Greenberg, 1969) following ventral stream lesions show a different and rather more remarkable pattern of impairment. Though these patients are unable to recognize common objects, they can navigate through the world. One such patient (D.F.) had a profound inability to recognize the size, shape, and orientation of visual objects; she could not, for example, indicate the size of an object with her finger and thumb. However, when she was asked simply to pick up an object, her grip adjusted normally to the size of the object (Goodale *et al.*, 1991). She was unable to indicate the orientation of a slot, either verbally or by rotating a hand-held card, but when she was required to post a card through the slot, she performed perfectly normally from the start of the movement (Milner *et al.*, 1991; see figure below).

Visual awareness and object constancy in the ventral stream

Humans such as D.F., with only a dorsal visual stream, appear to have preserved visuomotor ability without conscious perception of the same information that drives their visuomotor performance. This may be likened to blindsight (which, recall, may be largely mediated by the dorsal stream). It has therefore been suggested that activity within the ventral stream is a prerequisite for conscious visual awareness (Goodale & Milner, 1992; Milner, 1998b).

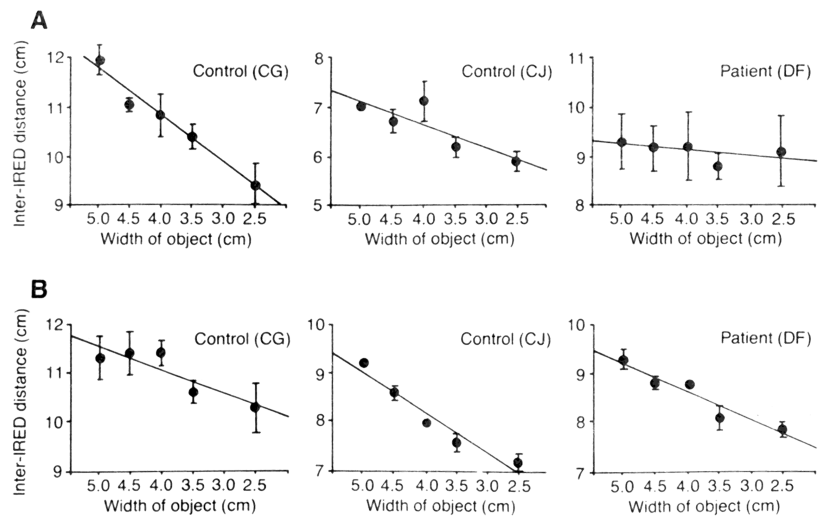
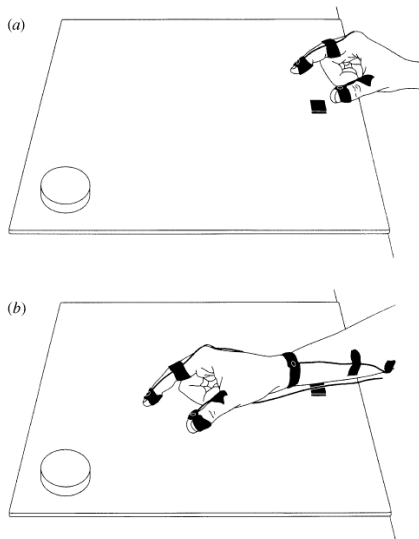

Patient D.F., a visual agnostic (following an anoxic, predominantly ventral stream lesion). Perception of size and orientation is impaired, but actions based on the same visual information are performed normally (Goodale *et al.*, 1991). **Top:** A, matching finger separation to size of object (D.F. is impaired); B, grasping object (D.F. is normal). 'Inter-IREd distance' refers to distance between thumb and index finger. **Bottom:** adjusting hand-held card orientation to match slot ('perceptual orientation matching') or posting the card through the slot ('visuomotor posting').

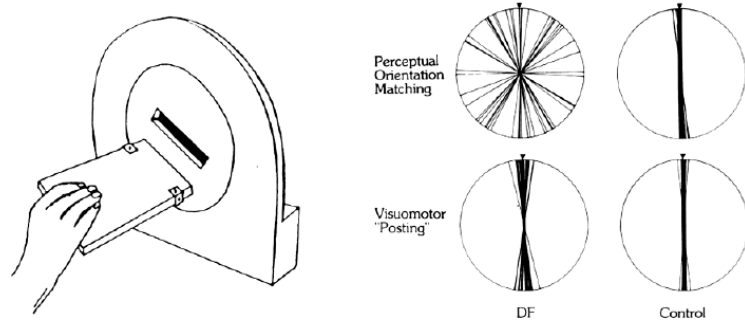

The ventral stream is 'object-centred': anterior ventral stream neurons in the temporal cortex retain their selective responsiveness to objects despite changes in the object's precise location, size, colour, illumination, and viewpoint (Perrett *et al.*, 1987; Perrett *et al.*, 1991). Lesions of the inferotemporal cortex (but not posterior parietal cortex) impair monkeys' ability to generalize their recognition of 3D shapes across viewing conditions (Humphrey & Weiskrantz, 1969; Weiskrantz & Saunders, 1984). In contrast, the information being processed by the dorsal stream is 'viewer-centred' (dependent upon the viewer's position) and may not help the 'object-centred' ventral stream. To illustrate the difference, normal subjects are typically unable to report whether or not a target has changed position during a saccadic eye movement; however, corrective saccades and manual reaching exhibit near-perfect adjustment if the target does move (see Goodale & Milner, 1992).

In other words, the ventral stream may maintain an illusion of object constancy that benefits object perception, while the dorsal stream provides motor functions that need to cope with the reality of non-constant object position, viewpoint, etc.

Interactions between the streams

These dissociations make the point that analysis of form and spatial features of stimuli cannot be totally independent — clearly, information about object form (shape, size) is being used for visuomotor functions including pre-shaping the hand for grasping. Indeed, Goodale & Milner (1992) make the point that the two streams interact anatomically.

The dorsal stream, neglect, and attention

We've discussed the phenomenon of neglect that can follow parietal cortex lesions, and hinted at the attentional functions of the parietal cortex (to be discussed in the next lecture). We should note that the attentional processes involved in neglect appear to be separable from the visuomotor functions of the parietal cortex, implicated in optic ataxia (Perenin & Vighetto, 1988; Goodale & Milner, 1992; Milner, 1998a).

Summary and conclusions

We have discussed the dorsal visual stream and parietal cortex, examining the response properties of its neurons and its role in motion processing, spatial cognition and visuomotor control. We have considered examples of visual processing without awareness, and touched on the complex deficits that follow posterior parietal cortex damage in humans and monkeys. In the next lecture, we will consider the neurobiology of attention and the binding problem.

Sample essay questions

- Critically evaluate the hypothesis of two visual processing ‘streams’.
- What do single unit electrophysiological studies contribute to our understanding of the parietal cortex? How have they helped us to understand the deficits of patients with damage to this area?
- How is space represented in the parietal cortex?

Suggested reading

- Goodale & Milner (1992) — ‘what’ v. ‘how’ hypothesis. Alternatively, Milner & Goodale (1995), a longer version.
- Goodale & Westwood (2004) — recent review of the visual streams.
- Colby & Olson (1999) — ch. 53 in *Fundamental Neuroscience*; clear exposition of neglect and parietal function.
- Stoerig & Cowey (1997) — excellent recent review of blindsight.
- Culham & Kanwisher (2001) — neuroimaging of the parietal cortex.
- Stein (1992) — on coordinate transformation systems within the posterior parietal cortex.

All references cited in the handout

(You’d be mad to read all these. Concentrate on the *Suggested Reading* list.)

- Baars, B. J. (1998). Metaphors of consciousness and attention in the brain. *Trends in Neurosciences* **21**: 58-62.
- Bálint, R. (1909). Seelenlähmung des ‘schauens’, optische ataxie, räumliche störung der aufmerksamkeit. *Monatsschr. Psychiatr. Neurol.* **25**: 51-81.
- Barbur, J. L., Watson, J. D., Frackowiak, R. S. & Zeki, S. (1993). Conscious visual perception without V1. *Brain* **116**: 1293-1302.
- Bard, L. (1905). De la persistance des sensations lumineuses dans le champ aveugle des hemianopsiques. *La Semaine Medicale* **22**: 253-255.
- Behrmann, M. (2000). Spatial reference frames and hemispatial neglect. In *The New Cognitive Neurosciences*, Second edition (Gazzaniga, M. S., ed.), pp. 651-666. MIT Press, Cambridge, MA.
- Benson, D. F. & Greenberg, J. P. (1969). Visual form agnosia: a specific deficit in visual discrimination. *Archives of Neurology* **20**: 82-89.
- Beschin, N., Basso, A. & Della Sala, S. (2000). Perceiving left and imagining right: dissociation in neglect. *Cortex* **36**: 401-414.
- Bisiach, E. & Luzzatti, C. (1978). Unilateral neglect of representational space. *Cortex* **14**: 129-133.
- Bisiach, E., Luzzatti, C. & Perani, D. (1979). Unilateral neglect, representational schema and consciousness. *Brain* **102**: 609-618.
- Bremmer, F., Distler, C. & Hoffmann, K. P. (1997). Eye position effects in monkey cortex. II. Pursuit- and fixation-related activity in posterior parietal areas LIP and 7A. *Journal of Neurophysiology* **77**: 962-977.
- Bridgeman, B. (1994). A theory of visual stability across saccadic eye movements. *Behavioral and Brain Sciences* **17**: 247-292.
- Cohen, M. R. & Newsome, W. T. (2004). What electrical microstimulation has revealed about the neural basis of cognition. *Current Opinion in Neurobiology* **14**: 169-177.
- Colby, C. L. & Olson, C. R. (1999). Spatial cognition. In *Fundamental Neuroscience* (Zigmond, M. J., Bloom, F. E., Landis, S. C., Roberts, J. L. & Squire, L. R., eds.), pp. 1363-1383. Academic Press, London.
- Cowey, A. & Weiskrantz, L. (1963). A perimetric study of visual field defects in monkeys. *Quarterly Journal of Experimental Psychology* **15**: 91-115.
- Culham, J. C. & Kanwisher, N. G. (2001). Neuroimaging of cognitive functions in human parietal cortex. *Current Opinion in Neurobiology* **11**: 157-163.
- DeYoe, E. A. & van Essen, D. C. (1988). Concurrent processing streams in monkey visual cortex. *Trends in Neurosciences* **11**: 219-226.
- Duhamel, J. R., Colby, C. L. & Goldberg, M. E. (1991). Congruent representations of visual and somatosensory space in single neurons of monkey ventral intra-parietal cortex (area VIP). In *Brain and Space* (Paillard, J., ed.), pp. 223-236. Oxford University Press, Oxford.
- Duhamel, J. R., Colby, C. L. & Goldberg, M. E. (1992a). The updating of the representation of visual space in parietal cortex by intended eye movements. *Science* **255**: 90-92.
- Duhamel, J. R., Goldberg, M. E., Fitzgibbon, E. J., Sirigu, A. & Grafman, J. (1992b). Saccadic dysmetria in a patient with a right fronto-parietal lesion. The importance of corollary discharge for accurate spatial behaviour. *Brain* **115**: 1387-1402.
- Gallese, V., Murata, A., Kaseda, M., Niki, N. & Sakata, H. (1994). Deficit of hand preshaping after muscimol injection in monkey parietal cortex. *Neuroreport* **5**: 1525-1529.
- Garde, M. M. & Cowey, A. (2000). "Deaf hearing": unacknowledged detection of auditory stimuli in a patient with cerebral deafness. *Cortex* **36**: 71-80.
- Goodale, M. A. & Milner, A. D. (1992). Separate visual pathways for perception and action. *Trends in Neurosciences* **15**: 20-25.
- Goodale, M. A., Milner, A. D., Jakobson, L. S. & Carey, D. P. (1991). A neurological dissociation between perceiving objects and grasping them. *Nature* **349**: 154-156.
- Goodale, M. A. & Westwood, D. A. (2004). An evolving view of duplex vision: separate but interacting cortical pathways for perception and action. *Current Opinion in Neurobiology* **14**: 203-211.
- Güzelde, G., Flanagan, O. & Hardcastle, V. G. (2000). The nature and function of consciousness: lessons from blindsight. In *The New Cognitive Neurosciences*, pp. 1277-1284. MIT Press, Cambridge, MA.
- Humphrey, N. K. (1974). Vision in a monkey without striate cortex: a case study. *Perception* **3**: 241-255.
- Humphrey, N. K. & Weiskrantz, L. (1969). Size constancy in monkeys with inferotemporal lesions. *Quarterly Journal of Experimental Psychology* **21**: 225-238.
- Jakobson, L. S., Archibald, Y. M., Carey, D. P. & Goodale, M. A. (1991). A kinematic analysis of reaching and grasping movements in a patient recovering from optic ataxia. *Neuropsychologia* **29**: 803-809.
- Jeannerod, M., Decety, J. & Michel, F. (1994). Impairment of grasping movements following a bilateral posterior parietal lesion. *Neuropsychologia* **32**: 369-380.
- Lawler, K. A. & Cowey, A. (1987). On the role of posterior parietal and prefrontal cortex in visuo-spatial perception and attention. *Experimental Brain Research* **65**: 695-698.
- Milner, A. D. (1998a). Neuropsychological studies of perception and visuomotor control. *Philosophical Transactions of the Royal Society of London. Series B: Biological Sciences* **353**: 1375-1384.

- Milner, A. D. (1998b). Streams and consciousness: visual awareness and the brain. *Trends in Cognitive Sciences* **2**: 25-30.
- Milner, A. D. & Goodale, M. A. (1993). Visual pathways to perception and action. *Progress in Brain Research* **95**: 317-337.
- Milner, A. D. & Goodale, M. A. (1995). *The visual brain in action*, Oxford University Press, Oxford.
- Milner, A. D., Ockleford, E. M. & Dewar, W. (1977). Visuo-spatial performance following posterior parietal and lateral frontal lesions in stump-tail macaques. *Cortex* **13**: 350-360.
- Milner, A. D., Perrett, D. I., Johnston, R. S., Benson, P. J., Jordan, T. R., Heeley, D. W., Bettucci, D., Mortara, F., Mutani, R., Terazzi, E. & Davidson, D. L. W. (1991). Perception and action in 'visual form agnosia'. *Brain* **114**: 405-428.
- Mishkin, M., Lewis, M. E. & Ungerleider, L. G. (1982). Equivalence of parieto-preoccipital subareas for visuospatial ability in monkeys. *Behavioural Brain Research* **6**: 41-55.
- Mountcastle, V. B., Lynch, J. C., Georgopoulos, A., Sakata, H. & Acuna, C. (1975). Posterior parietal association cortex of the monkey: command functions for operations within extrapersonal space. *Journal of Neurophysiology* **38**: 871-908.
- Murata, A., Gallese, V., Kaseda, M. & Sakata, H. (1996). Parietal neurons related to memory-guided hand manipulation. *Journal of Neurophysiology* **75**: 2180-2186.
- Newcombe, F., Ratchiff, G. & Damasio, H. (1987). Dissociable visual and spatial impairments following right posterior cerebral lesions: clinical, neuropsychological and anatomical evidence. *Neuropsychologia* **25**: 149-161.
- Newsome, W. T., Wurtz, R. H., Dursteler, M. R. & Mikami, A. (1985). Deficits in visual motion processing following ibotenic acid lesions of the middle temporal visual area of the macaque monkey. *Journal of Neuroscience* **5**: 825-840.
- Ogden, J. A. (1985). Contralateral neglect of constructed visual images in right and left brain-damaged patients. *Neuropsychologia* **23**: 273-277.
- Perenin, M. T. (1991). Discrimination of motion direction in perimetricaly blind fields. *Neuroreport* **2**: 397-400.
- Perenin, M. T. & Vighetto, A. (1988). Optic ataxia: a specific disruption in visuomotor mechanisms. I. Different aspects of the deficit in reaching for objects. *Brain* **111**: 643-674.
- Perrett, D. I., Mistlin, A. J. & Chitty, A. J. (1987). Visual neurons responsive to faces. *Trends in Neurosciences* **10**: 358-364.
- Perrett, D. I., Oram, M. W., Harries, M. H., Bevan, R., Hietanen, J. K., Benson, P. J. & Thomas, S. (1991). Viewer-centred and object-centred coding of heads in the macaque temporal cortex. *Experimental Brain Research* **86**: 159-173.
- Pohl, W. (1973). Dissociation of spatial discrimination deficits following frontal and parietal lesions in monkeys. *Journal of Comparative and Physiological Psychology* **82**: 227-239.
- Pöppel, E., Held, R. & Frost, D. (1973). Residual visual function after brain wounds involving the central visual pathways in man. *Nature* **243**: 295-296.
- Riddoch, G. (1917). Dissociation of visual perception due to occipital injuries, with especial reference to appreciation of movement. *Brain* **40**: 15-57.
- Robertson, L. C. & Rafal, R. (2000). Disorders of visual attention. In *The New Cognitive Neurosciences*, Second edition (Gazzaniga, M. S., ed.), pp. 633-649. MIT Press, Cambridge, MA.
- Sakata, H., Taira, M., Kusunoki, M., Murata, A. & Tanaka, Y. (1997). The TINS Lecture. The parietal association cortex in depth perception and visual control of hand action. *Trends in Neurosciences* **20**: 350-357.
- Salzman, C. D., Britten, K. H. & Newsome, W. T. (1990). Cortical microstimulation influences perceptual judgements of motion direction. *Nature* **346**: 174-177.
- Sanders, M. D., Warrington, E. K., Marshall, J. & Weiskrantz, L. (1974). 'Blindsight': vision in a field defect. *Lancet* **1**: 707-708.
- Schneider, G. E. (1969). Two visual systems. *Science* **163**: 895-902.
- Shipp, S., de Jong, B. M., Zihl, J., Frackowiak, R. S. & Zeki, S. (1994). The brain activity related to residual motion vision in a patient with bilateral lesions of V5. *Brain* **117**: 1023-1038.
- Snyder, L. H., Grieve, K. L., Brotchie, P. & Andersen, R. A. (1998). Separate body- and world-referenced representations of visual space in parietal cortex. *Nature* **394**: 887-891.
- Stein, J. F. (1992). The representation of egocentric space in the posterior parietal cortex. *Behavioral and Brain Sciences* **15**: 691-700.
- Stoerig, P. & Cowey, A. (1997). Blindsight in man and monkey. *Brain* **120**: 535-559.
- Tsutsui, K., Sakata, H., Naganuma, T. & Taira, M. (2002). Neural correlates for perception of 3D surface orientation from texture gradient. *Science* **298**: 409-412.
- van Essen, D. C. & DeYoe, E. A. (1995). Concurrent processing in the primate visual cortex. In *The Cognitive Neurosciences* (Gazzaniga, M. S., ed.), pp. 383-400. MIT Press, Cambridge, MA.
- Weiskrantz, L. (1986). *Blindsight: a case study and implications*, Clarendon Press, Oxford.
- Weiskrantz, L. & Saunders, R. C. (1984). Impairments of visual object transforms in monkeys. *Brain* **107**: 1033-1072.
- Weiskrantz, L., Warrington, E. K., Sanders, M. D. & Marshall, J. (1974). Visual capacity in the hemianopic field following a restricted occipital ablation. *Brain* **97**: 709-728.
- Zeki, S. (1993). *A Vision of the Brain*, Blackwell, Oxford.
- Zeki, S., Watson, J. D. G., Lueck, C. J., Friston, K. J., Kennard, C. & Frackowiak, R. S. J. (1991). A direct demonstration of functional specialization in human visual cortex. *Journal of Neuroscience* **11**: 641-649.
- Zigmond, M. J., Bloom, F. E., Landis, S. C., Roberts, J. L. & Squire, L. R., Eds. (1999). *Fundamental Neuroscience*. London: Academic Press.
- Zihl, J., von Cramon, D. & Mai, N. (1983). Selective disturbance of movement vision after bilateral brain damage. *Brain* **106**: 313-340.