

NST II Psychology

NST II Neuroscience (Module 5)

Brain Mechanisms of Memory and Cognition – 4

Forms of memory.

Neural basis of memory (1):
amnesia, the hippocampus

Rudolf Cardinal

Department of Experimental Psychology

Monday 12, 19, 26 Jan; 2, 9, 23 Feb 2004; 10 am

Physiology Main Lecture Theatre

Slides will be at pobox.com/~rudolf/psychology



Types of memory

Types of memory

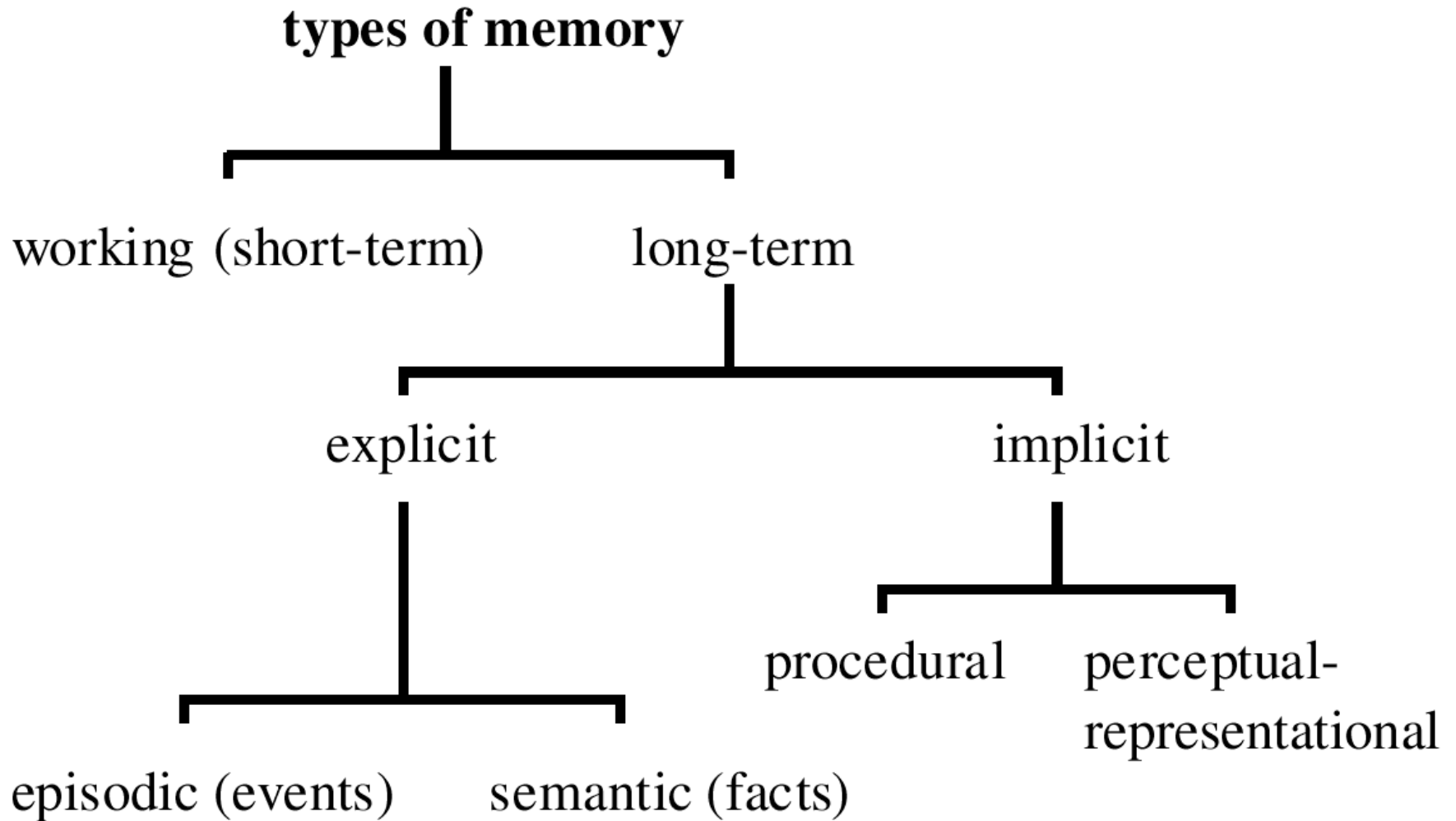

Morris (2001), after Tulving

STM is very S

hear 'QKN'... delay with distractor task... recall?

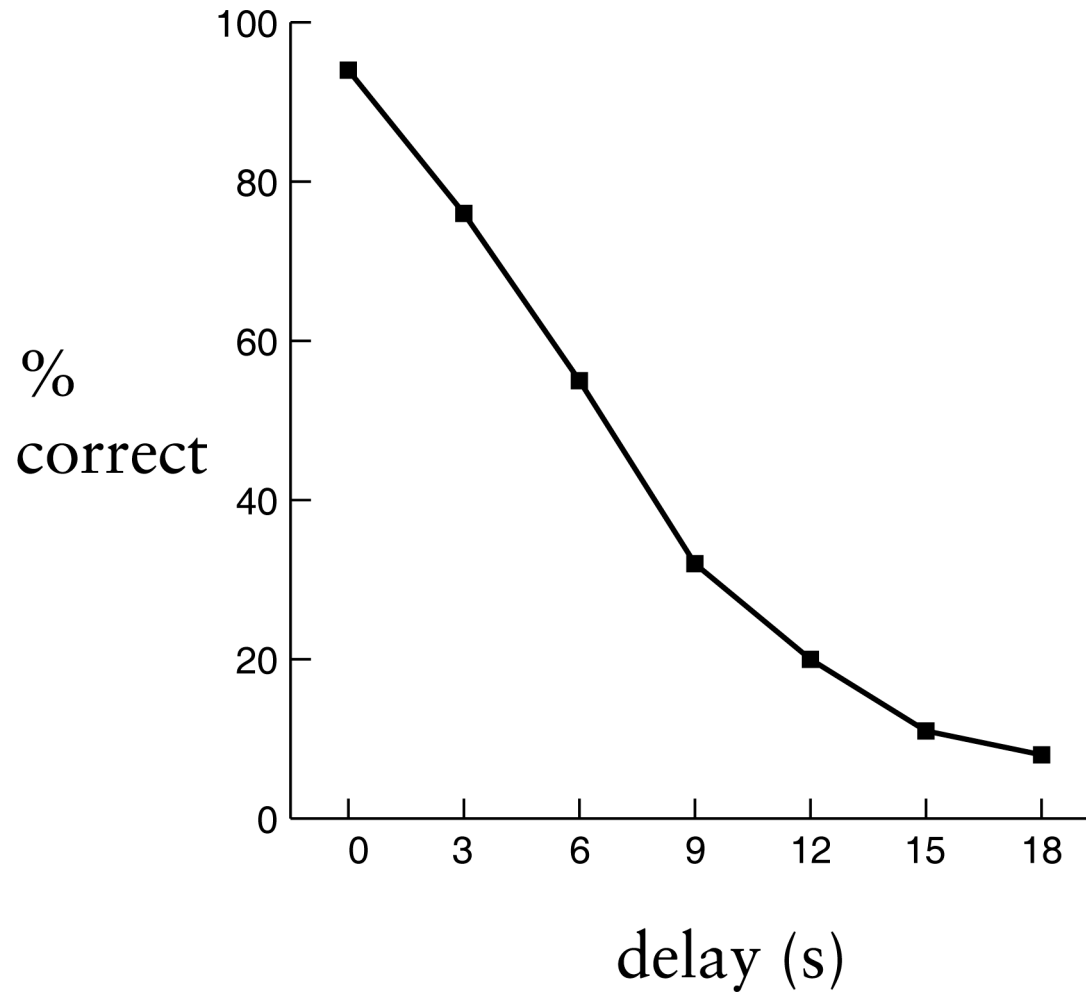

Peterson & Peterson (1959)

Types of memory

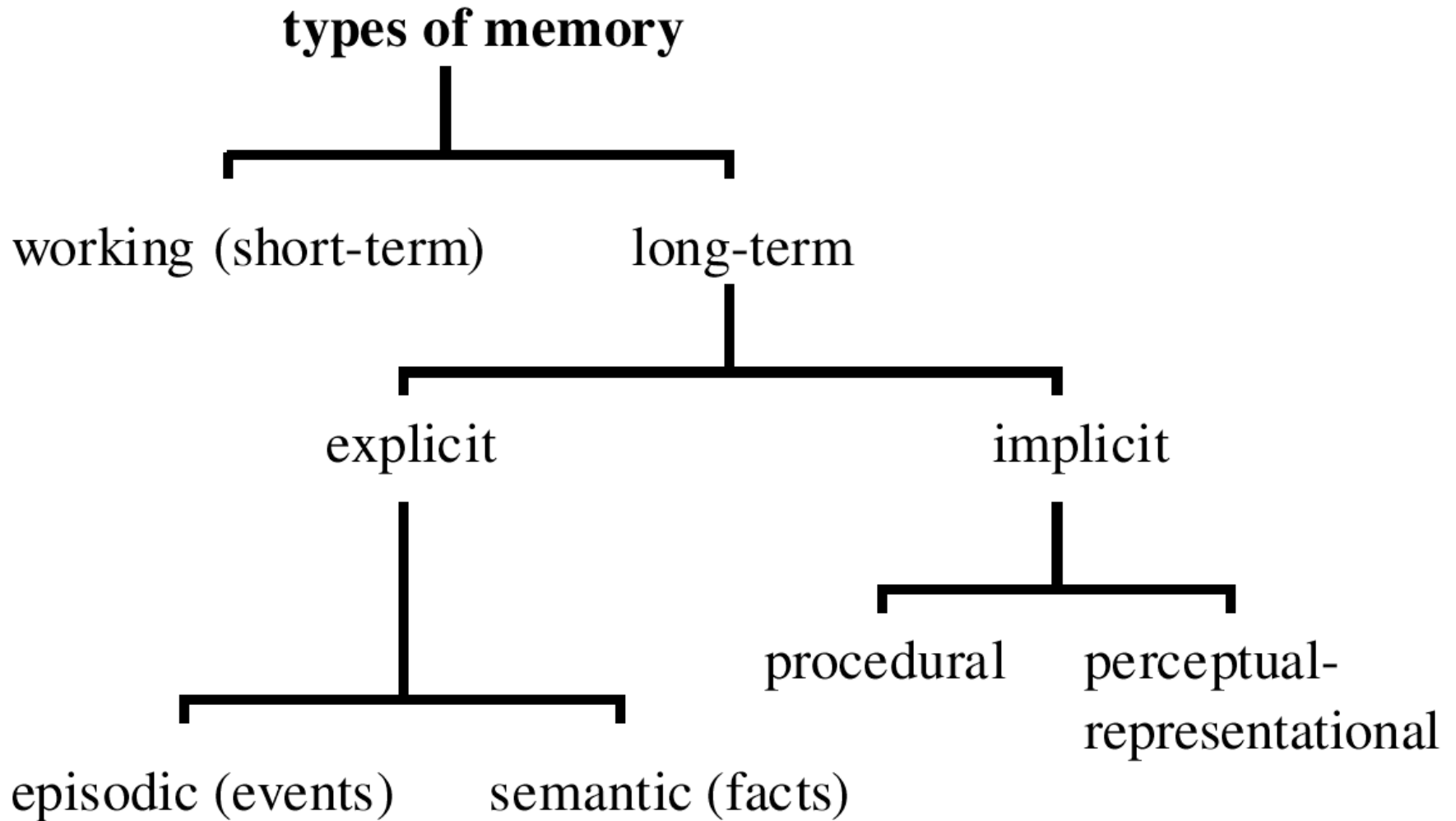

Morris (2001), after Tulving

Episodic versus semantic memory

'The accident rate while parachuting is 30 per 100,000 jumps.'

Semantic



Episodic

'What, where, when' - episodic-like memory in scrub jays (1)



Clayton & Dickinson (1998)

'What, where, when' - episodic-like memory in scrub jays (2)



Clayton & Dickinson (1998)

'What, where, when' - episodic-like memory in scrub jays (3)

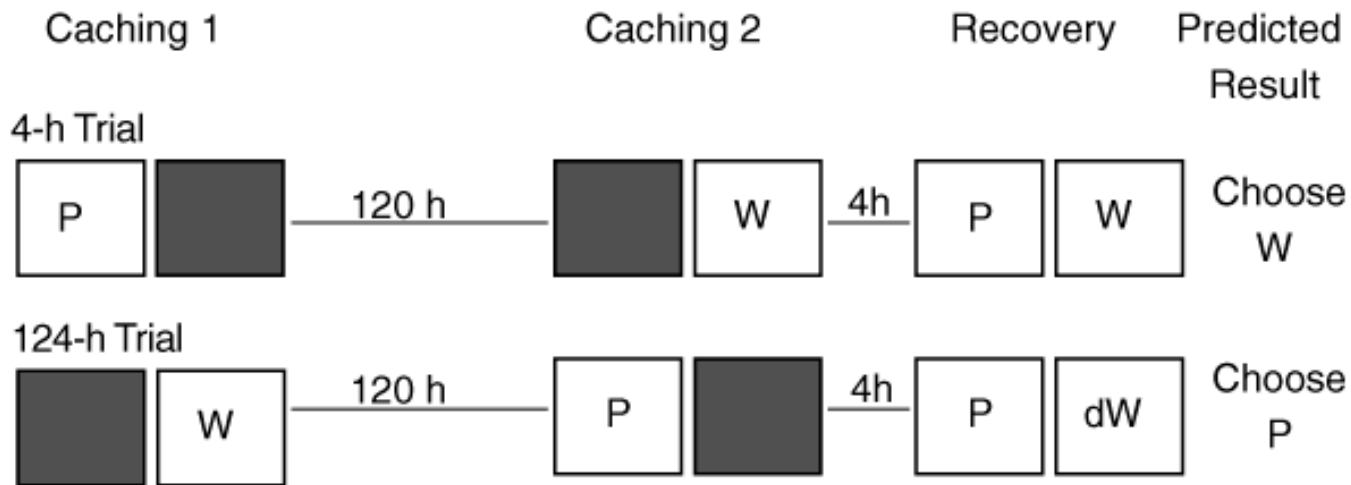

= Available cache sites
 = Unavailable cache sites

P = peanut caches
 W = worm caches
 dW = decayed worm caches

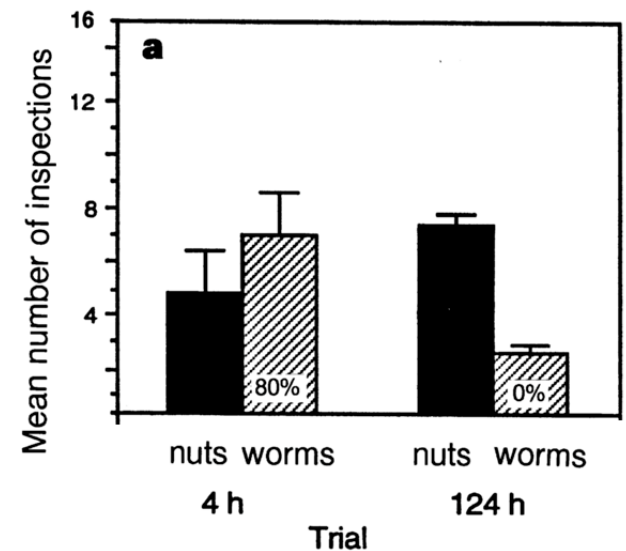

Semantic memory... categories



©jim davis



Semantic memory: cortical, distributed, related to perception?

Extracting general properties by the consistent activation of common elements.

If a network perceives three cats, there will be elements unique to each cat (1) (2) (3) and elements common to all cats (1,2,3). Is this *catness*?

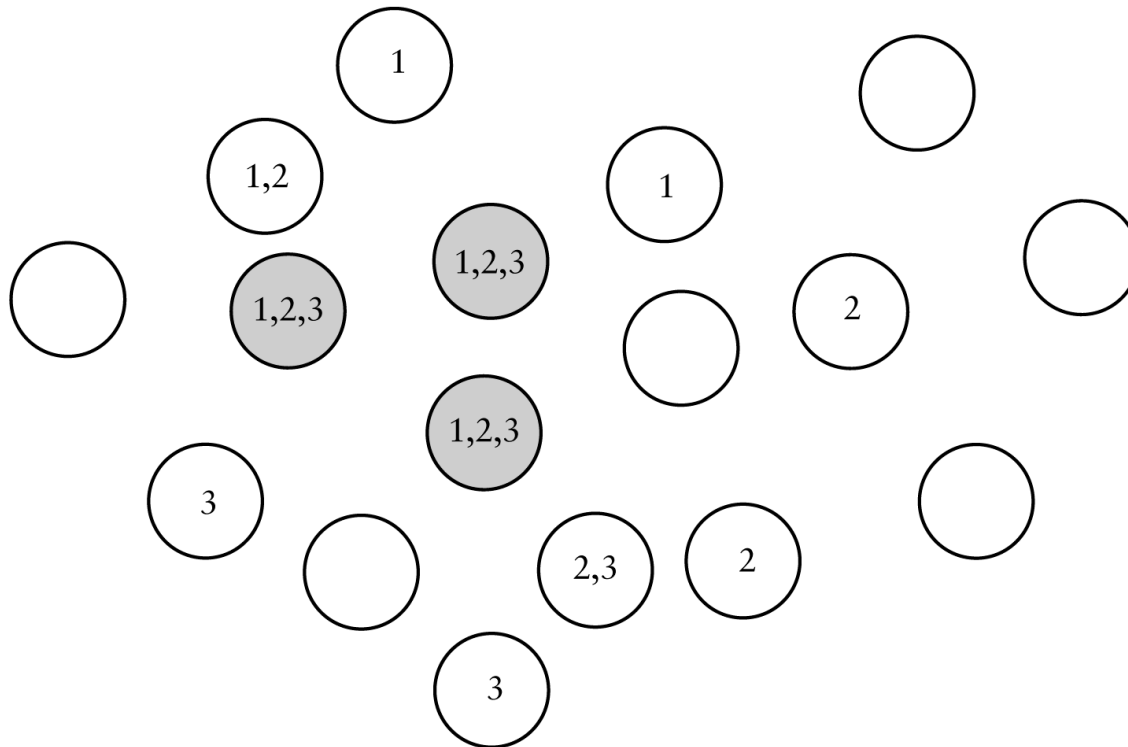

Procedural versus declarative memory

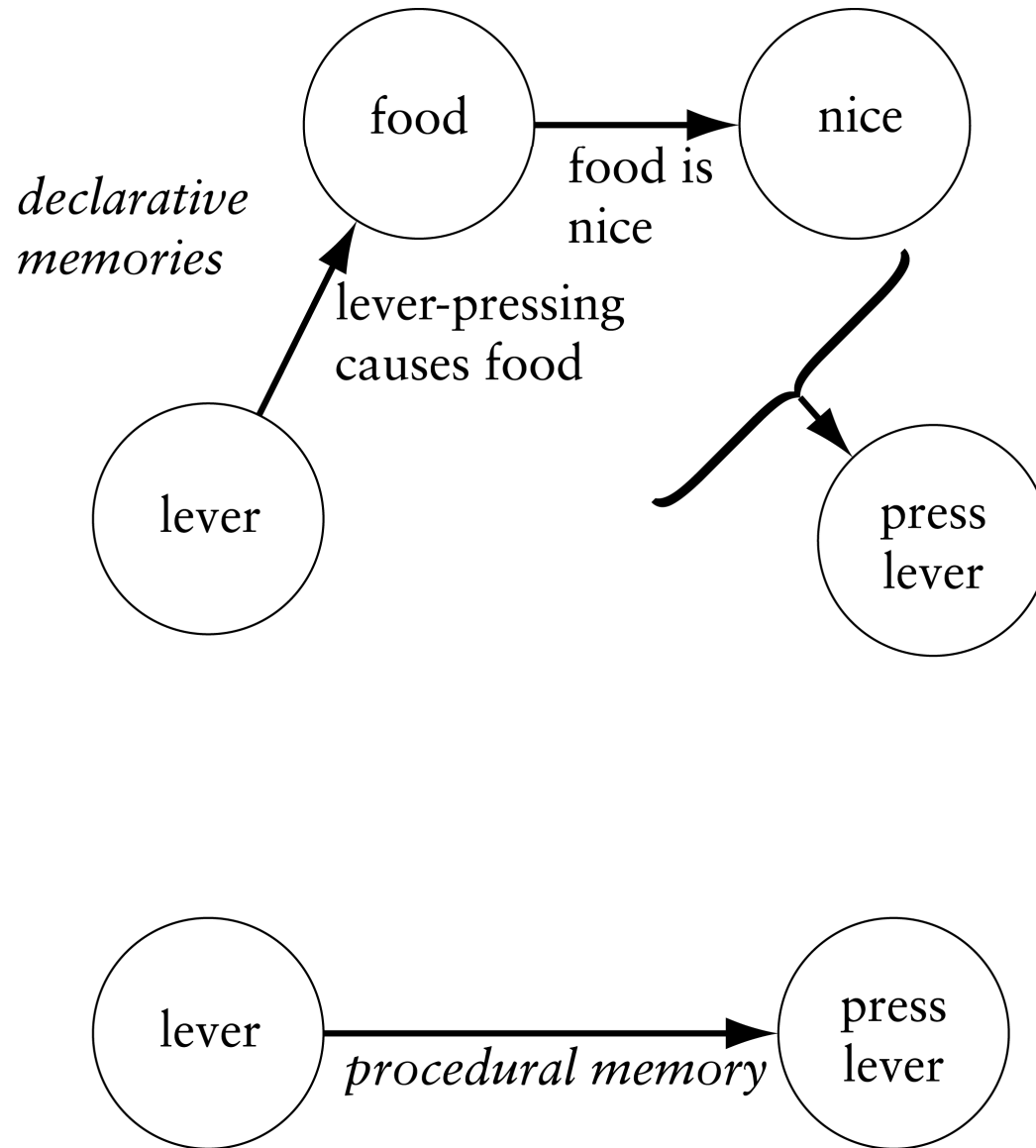

after Dickinson (1980)

Priming

<u>Preceding stimulus</u>	<u>Target to be classified (RT is measured)</u>	
north	doctor	
nuber	doctor	
nurse	doctor	<i>shorter RT - semantic priming</i>

Human amnesia



(Official Selection - Toronto Film Festival) (Official Selection - Venice Film Festival) (Official Selection - Sundance Film Festival)
GUY PEARCE CARRIE-ANNE MOSS JOE PANTOLIANO

MEMENTO

NEW LINE CINEMA PRESENTS A FILM BY JOE PANTOLIANO "MEMENTO" STARRING GUY PEARCE AND CARRIE-ANNE MOSS
CASTING BY JAMES NEWTON HOWARD COSTUME DESIGNER JAMES NEWTON HOWARD
PRODUCTION DESIGNER JAMES NEWTON HOWARD EXECUTIVE PRODUCERS JAMES NEWTON HOWARD
PRODUCED BY JAMES NEWTON HOWARD WRITTEN BY JOHN DOLY PRODUCED BY JOHN DOLY
DIRECTED BY JOE PANTOLIANO
CASTING BY JAMES NEWTON HOWARD COSTUME DESIGNER JAMES NEWTON HOWARD
PRODUCTION DESIGNER JAMES NEWTON HOWARD EXECUTIVE PRODUCERS JAMES NEWTON HOWARD
PRODUCED BY JAMES NEWTON HOWARD WRITTEN BY JOHN DOLY PRODUCED BY JOHN DOLY
DIRECTED BY JOE PANTOLIANO
CASTING BY JAMES NEWTON HOWARD COSTUME DESIGNER JAMES NEWTON HOWARD
PRODUCTION DESIGNER JAMES NEWTON HOWARD EXECUTIVE PRODUCERS JAMES NEWTON HOWARD
PRODUCED BY JAMES NEWTON HOWARD WRITTEN BY JOHN DOLY PRODUCED BY JOHN DOLY
DIRECTED BY JOE PANTOLIANO

NEW LINE CINEMA
R
© 2001 New Line Productions, Inc. All Rights Reserved.

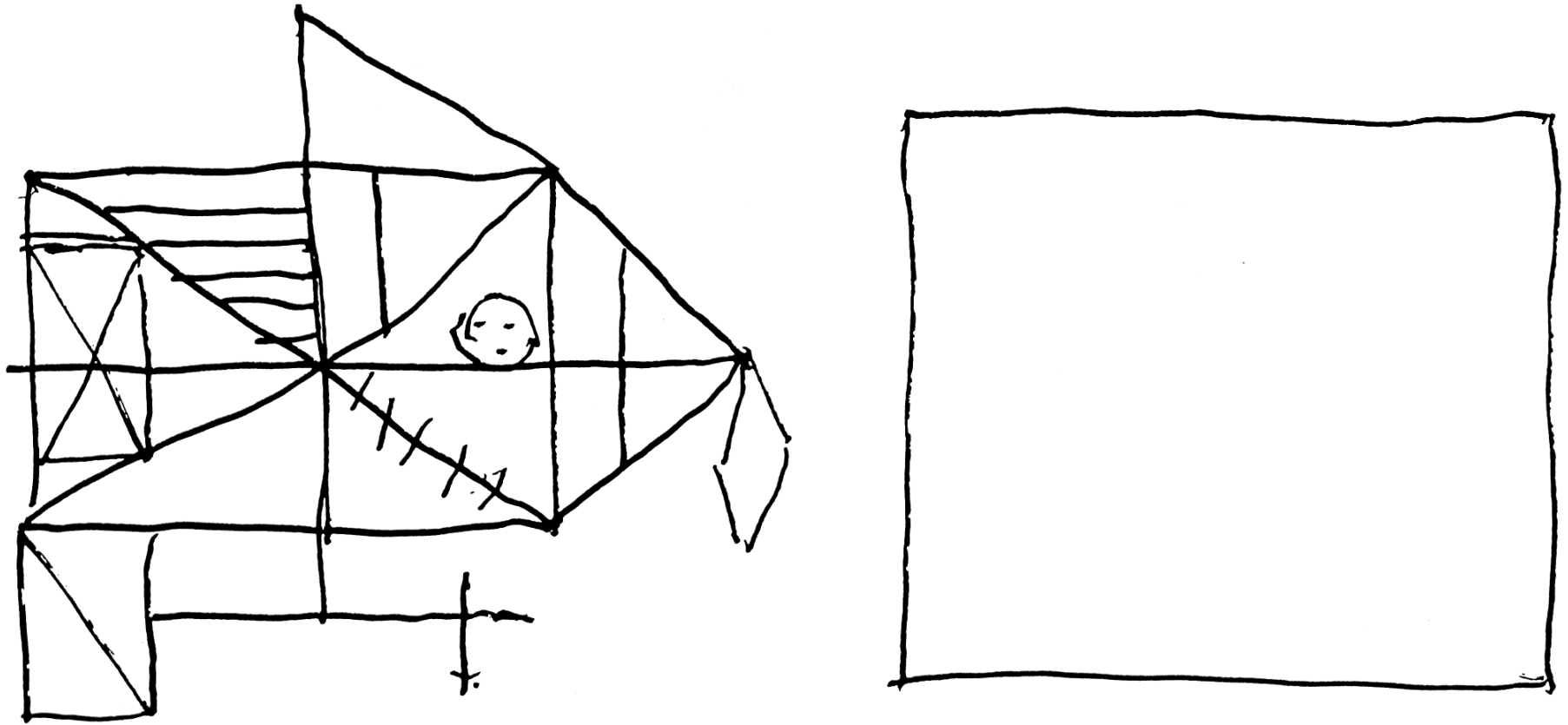
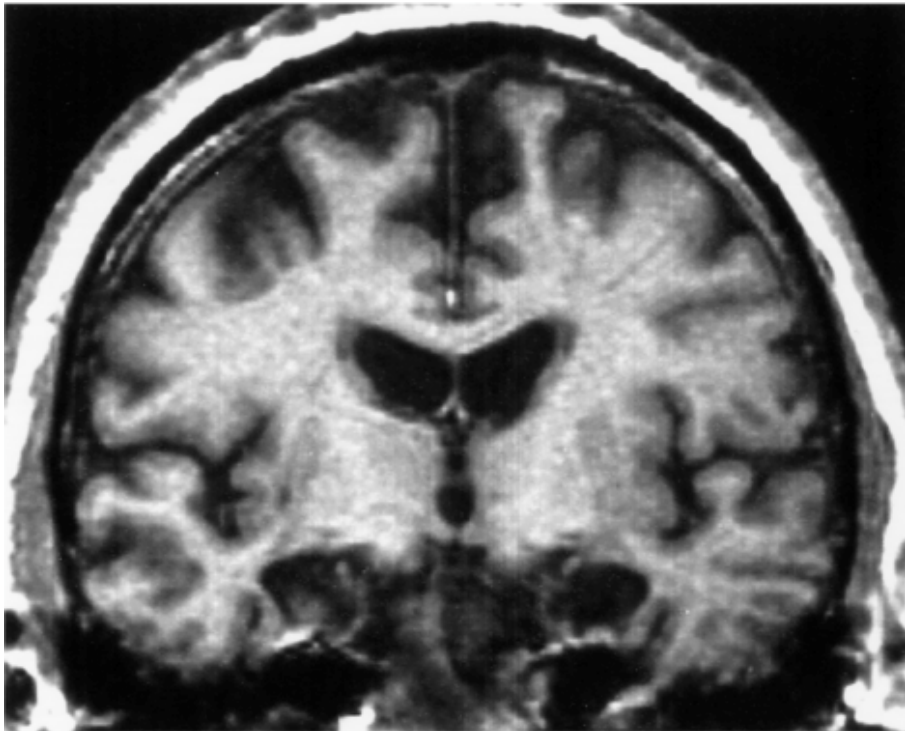

FIGURE 48.6 The performance of a bilateral diencephalic damaged patient with dense amnesia in copying the Rey-Osterrieth figure (top) and his attempt at redrawing it by heart immediately after having seen and copied it. (Results on case A. B. of Markowitsch, von Cramon, and Schuri, 1993.)

from Markowitsch (1995)

H.M.'s bilateral medial temporal lobe resection on MRI



H.M.

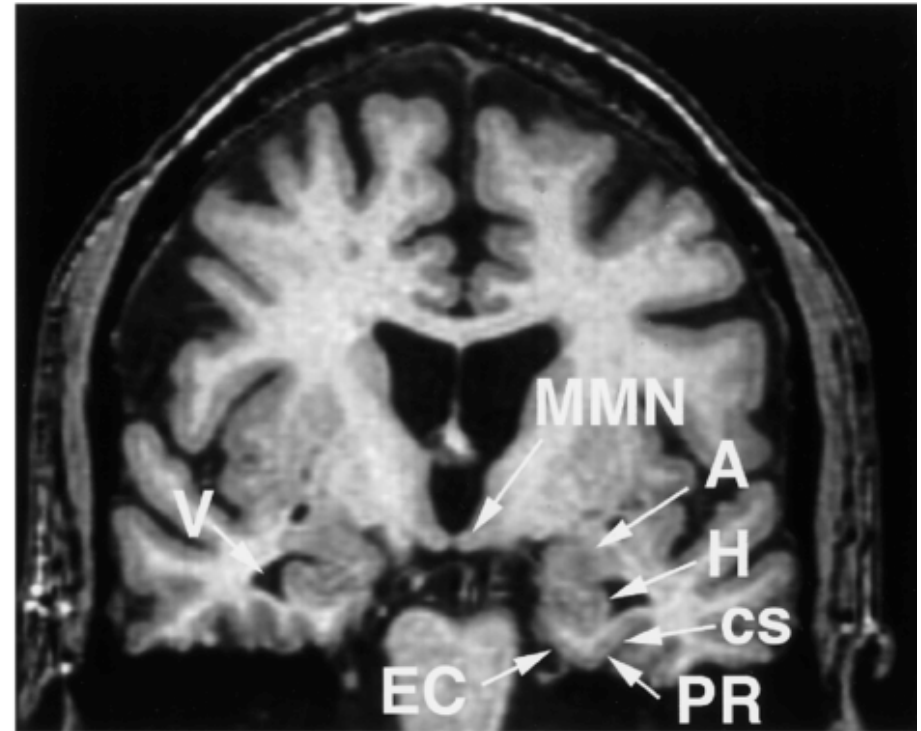

normal brain

*EC entorhinal cortex, MMN medial mammillary nucleus; A amygdala; H hippocampus
CS collateral sulcus; PR perirhinal cortex*

1953 operation: Scoville & Milner (1957) J Neurol Neurosurg Psych 20: 11

MRI: Corkin et al. (1997) J Neuro 17: 3694

H.M.'s amnesia

“He could not recognize the hospital staff, apart from Dr Scoville himself, whom he had known for many years; he did not remember and could not relearn the way to the bathroom, and he seemed to retain nothing of the day-to-day happenings in the hospital... A year later, H.M. had not yet learned the new address, nor could he be trusted to find his way home alone... He is unable to learn where objects constantly in use are kept.” (Milner, 1966)

Preserved abilities in medial temporal lobe amnesia

Profound anterograde amnesia. Impaired recognition. Some retrograde amnesia (temporally graded).

But

- **IQ** normal
- Could learn mirror-writing (Milner 1962, 1965) and similar **motor skills** day-by-day, despite inability to remember that he'd done it before.
- Learned a perceptual learning task (recognition of words from incomplete fragments)
- Improved with practice on the Tower of Hanoi task (Cohen 1984)
- **Short-term memory:** normal digit span and visual immediate memory
- **Priming** normal (typical of amnesiacs, see Aggleton & Brown 1999)

McCarthy & Warrington (1990)

Priming is intact in amnesiacs

ABSENT	ABS_____
INCOME	INC_____
FILLY	FIL_____
DISCUSS	DIS_____
CHEESE	CHE_____
ELEMENT	ELE_____

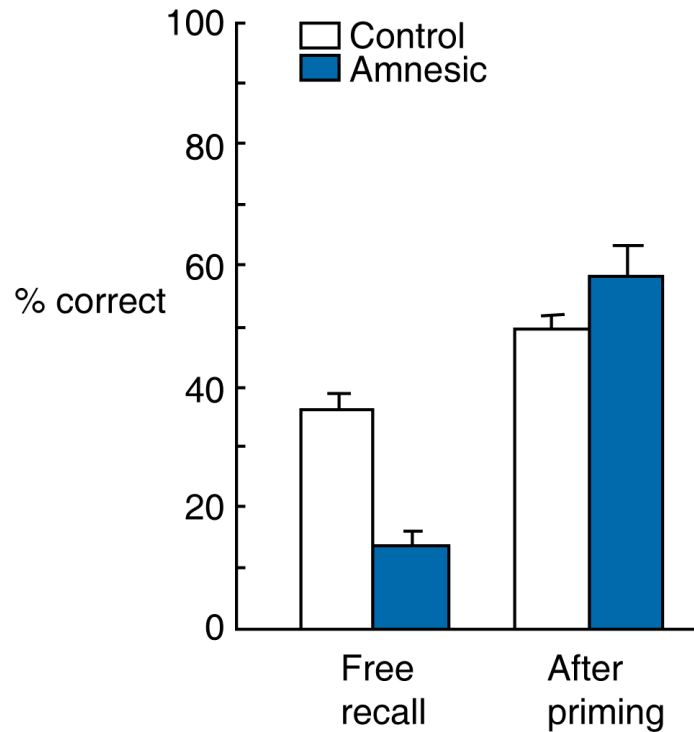

Graf et al. (1984)

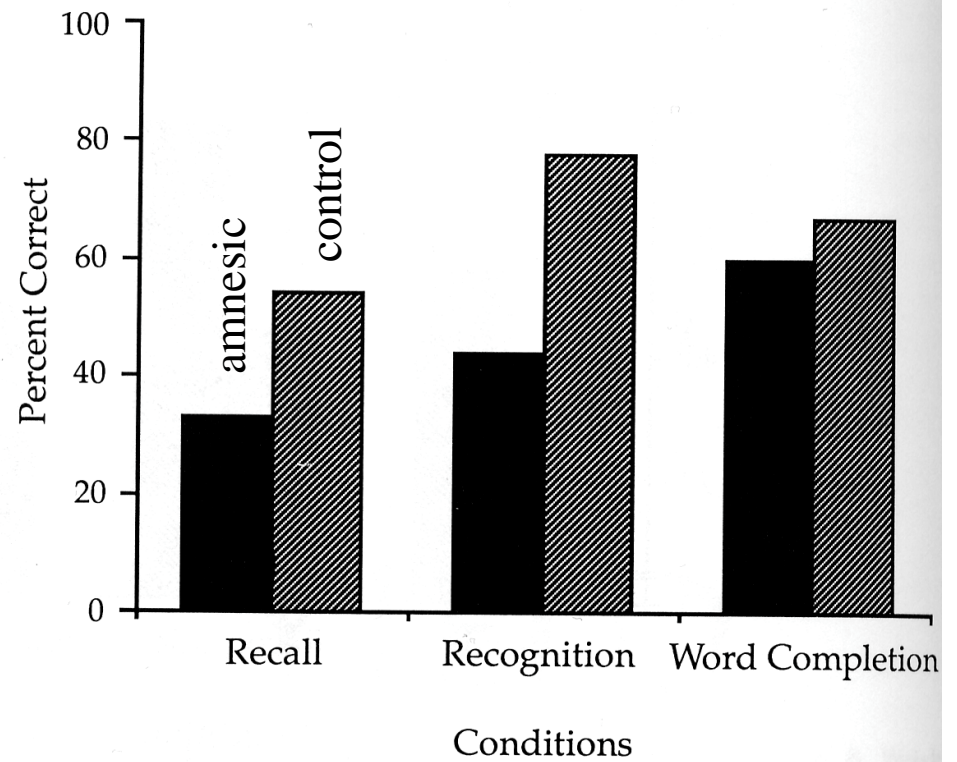

Warrington & Weiskrantz (1970)

Learning skills (procedural memory)

H.M. improved with practice
on mirror-drawing and mirror-reading
tasks, from session to session.

Yet he could not remember
practising.

The medial temporal lobe: hippocampus, amygdala, fornix

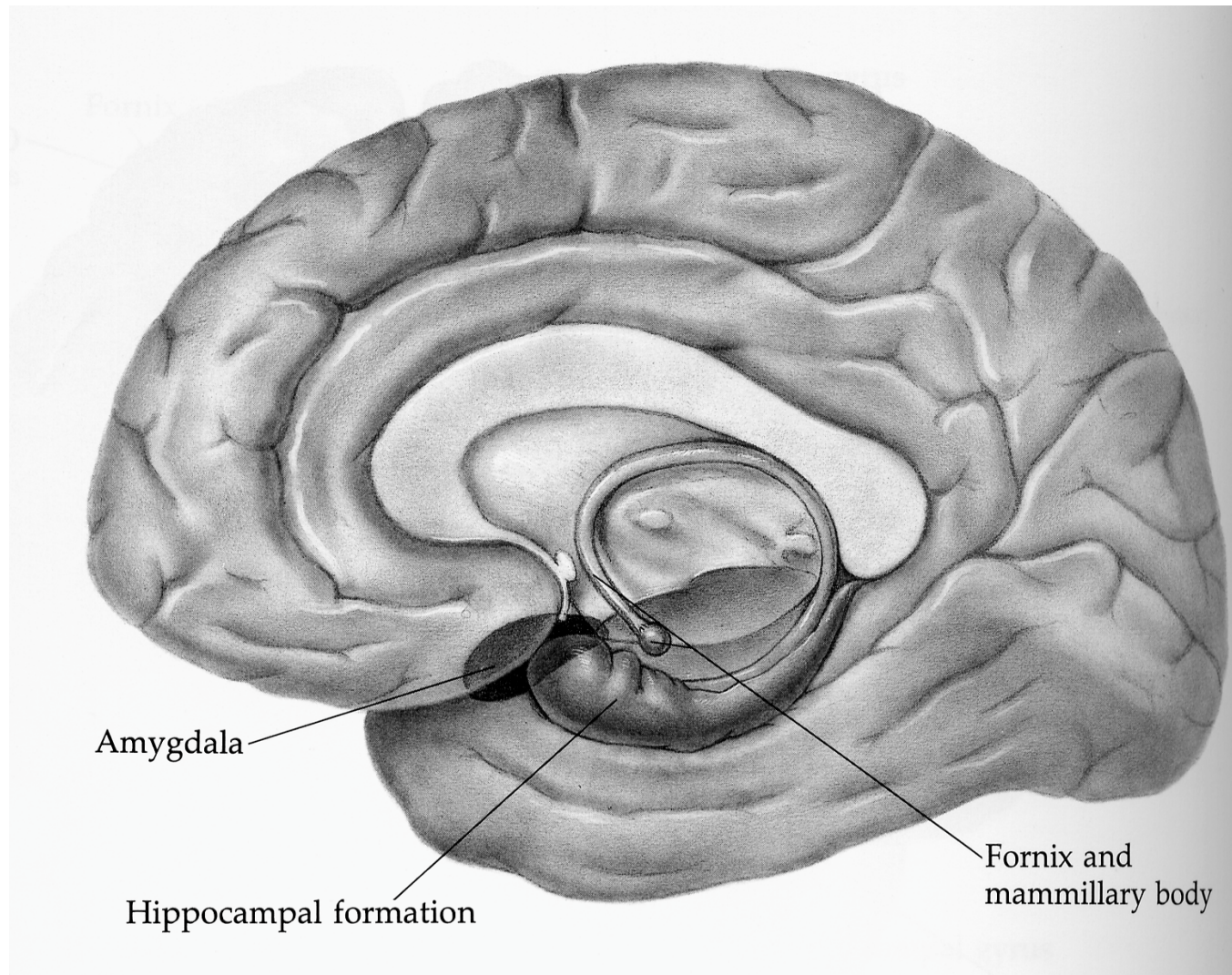

Medial temporal lobe and fornix

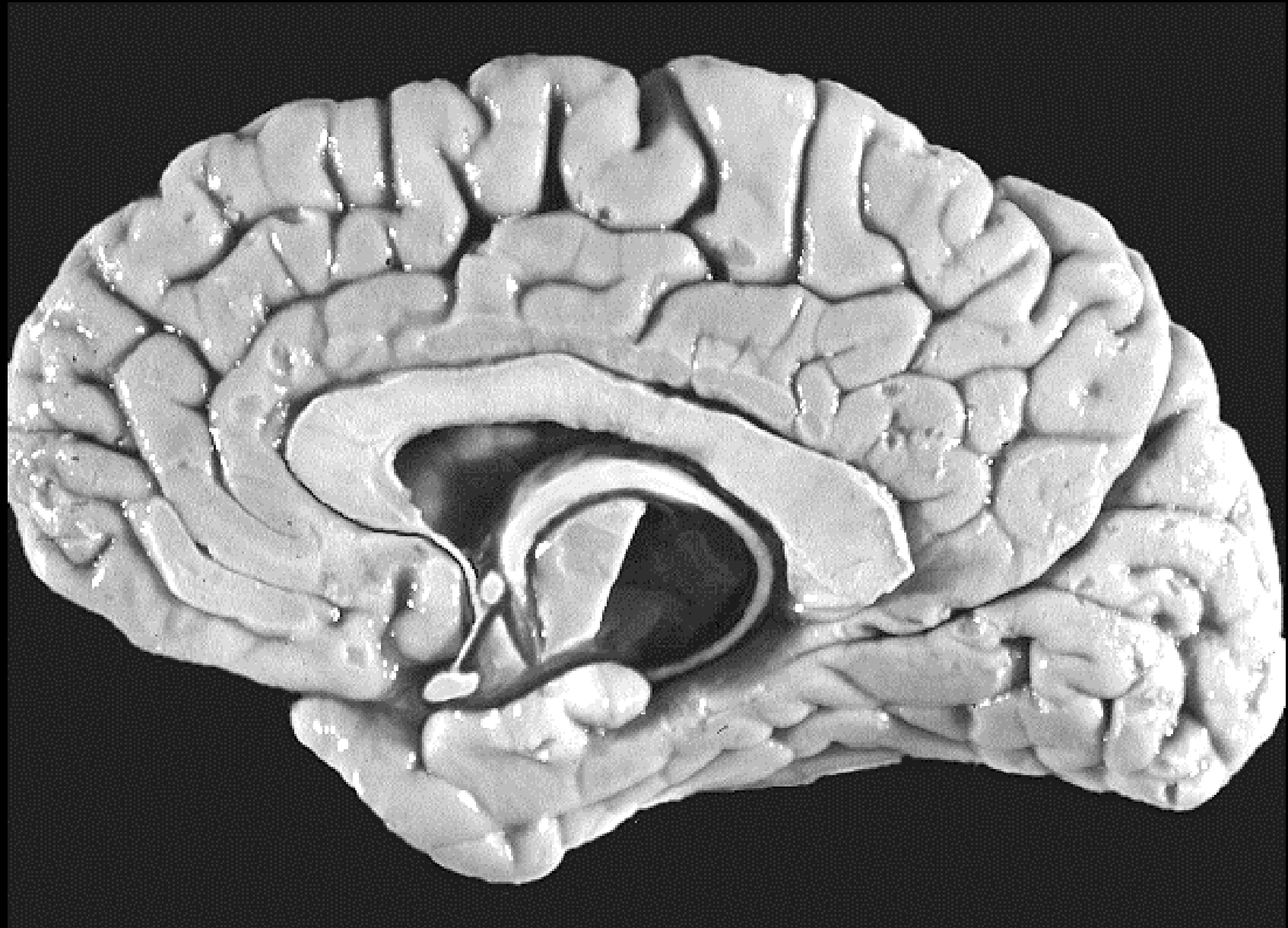

The hippocampal formation in cross-section (1)

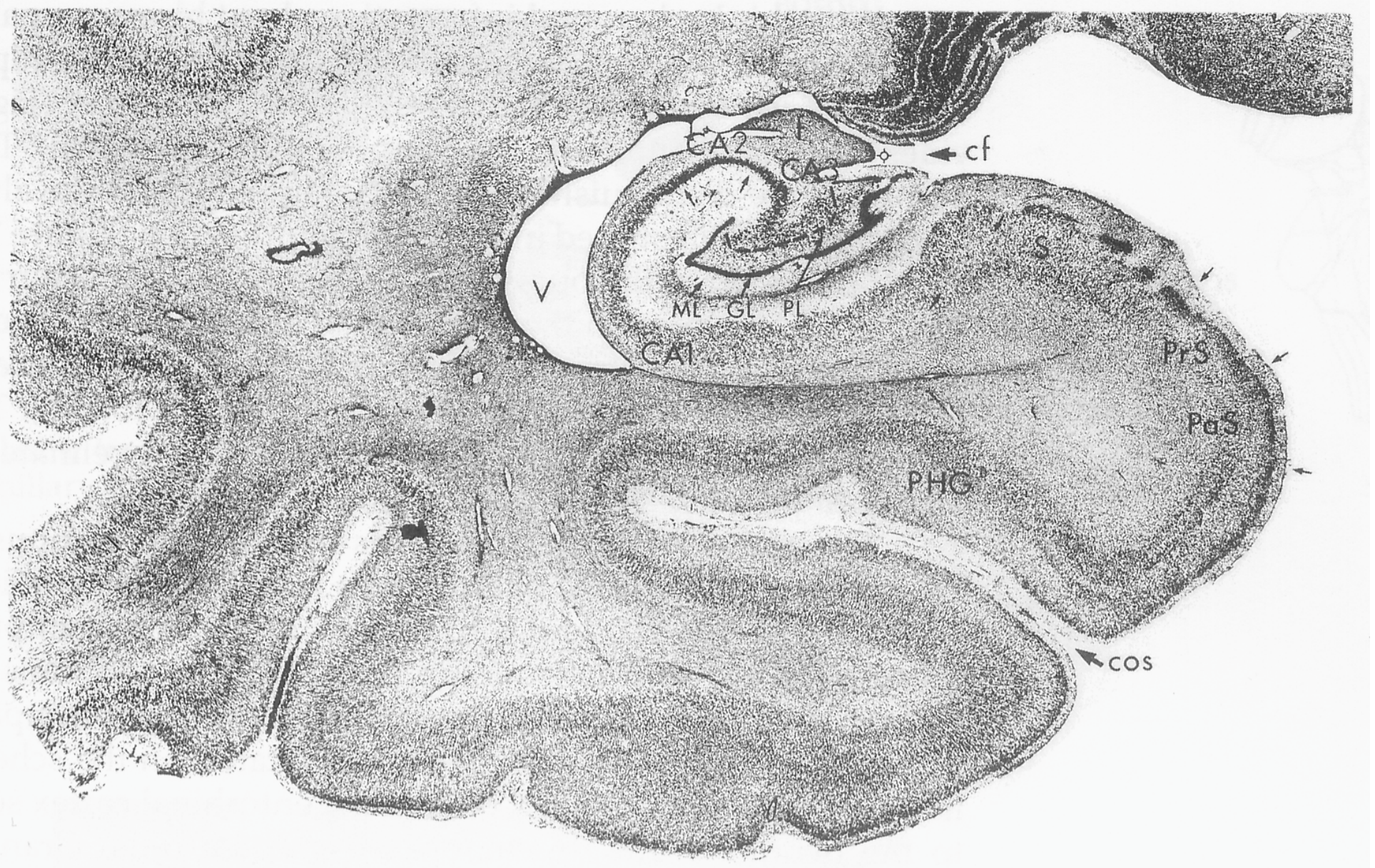

Martin (1989, p391)

The hippocampal formation in cross-section (2)



The hippocampal formation in cross-section (approx.!)

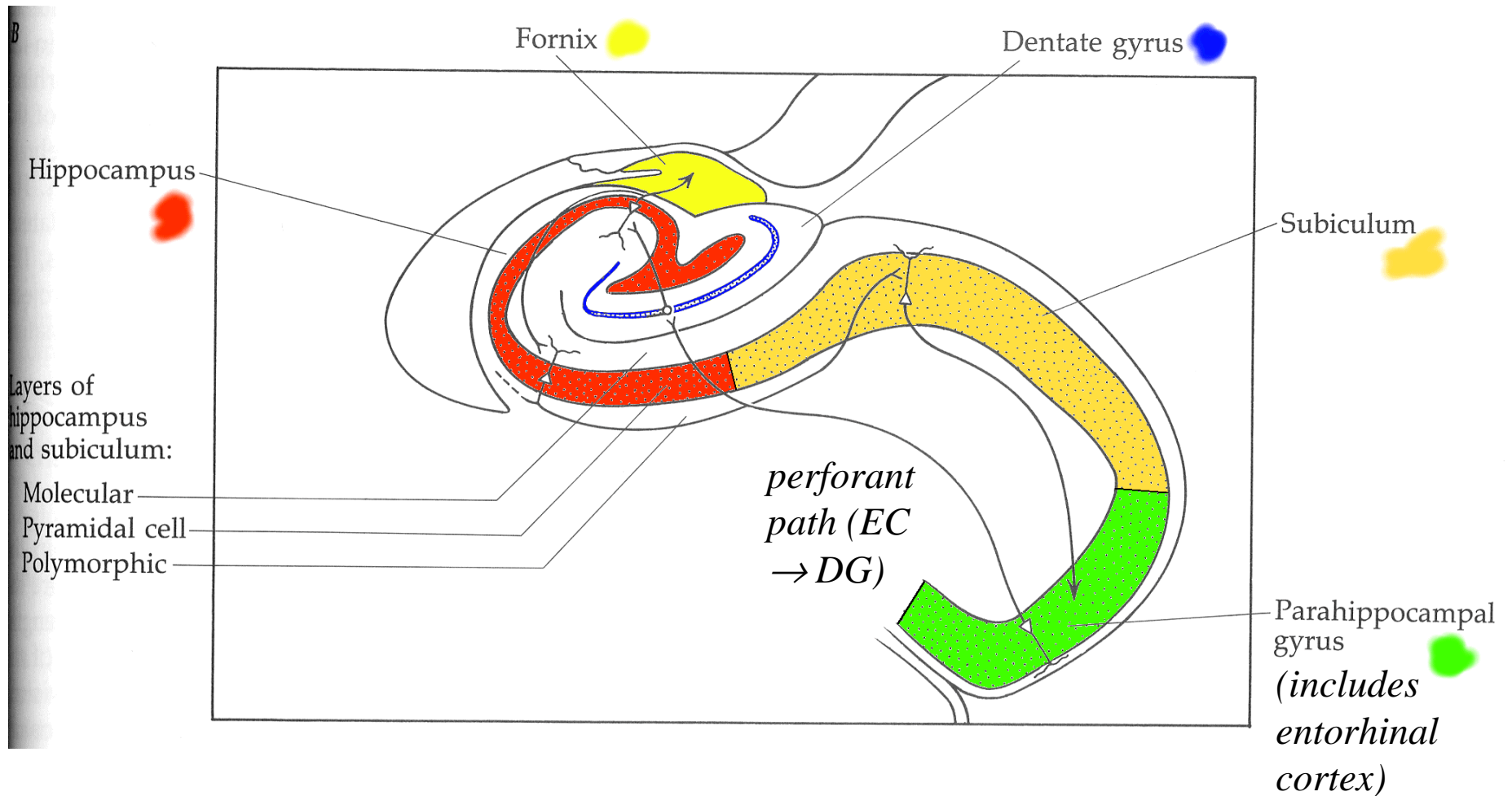

Martin (1989, p391, modified)

Connections within the hippocampal formation

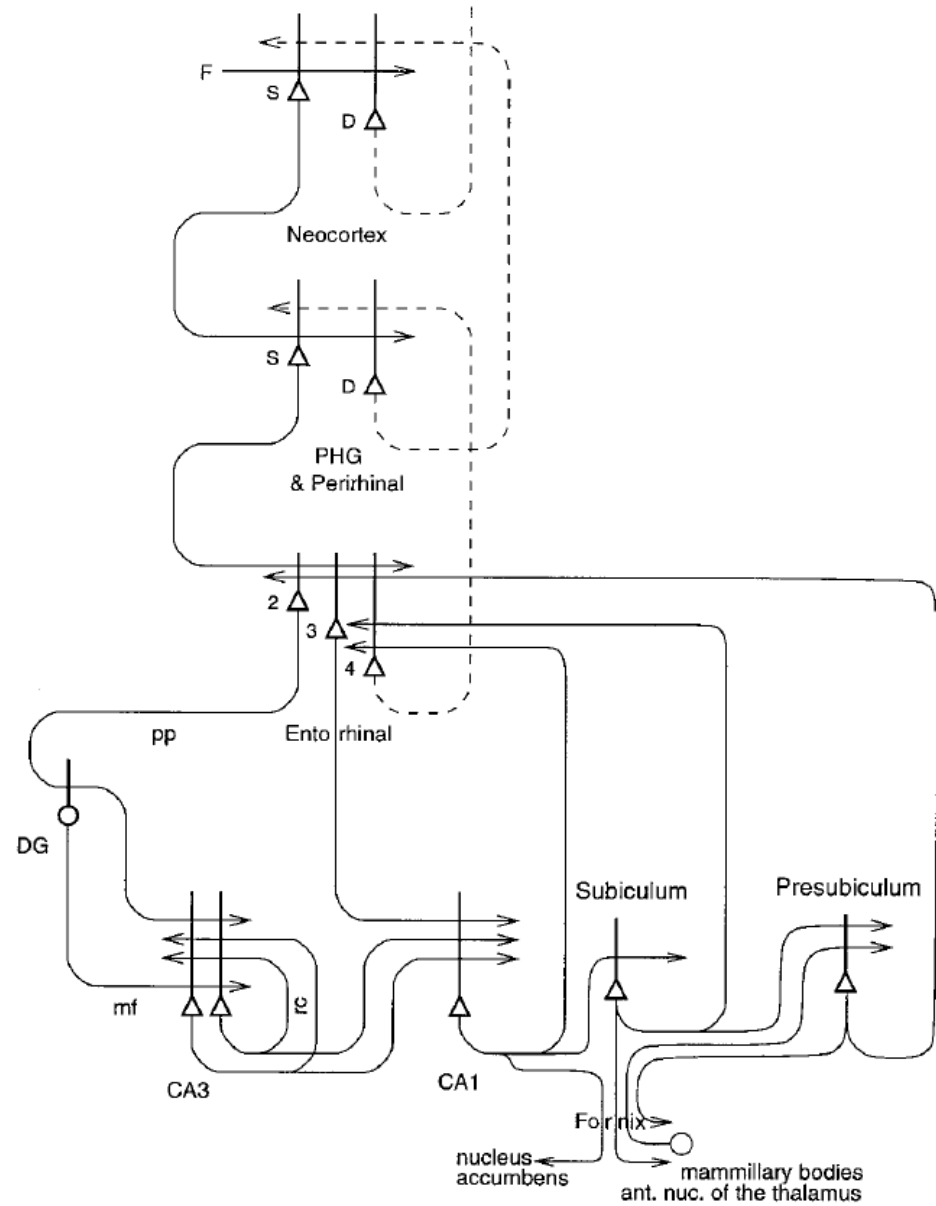
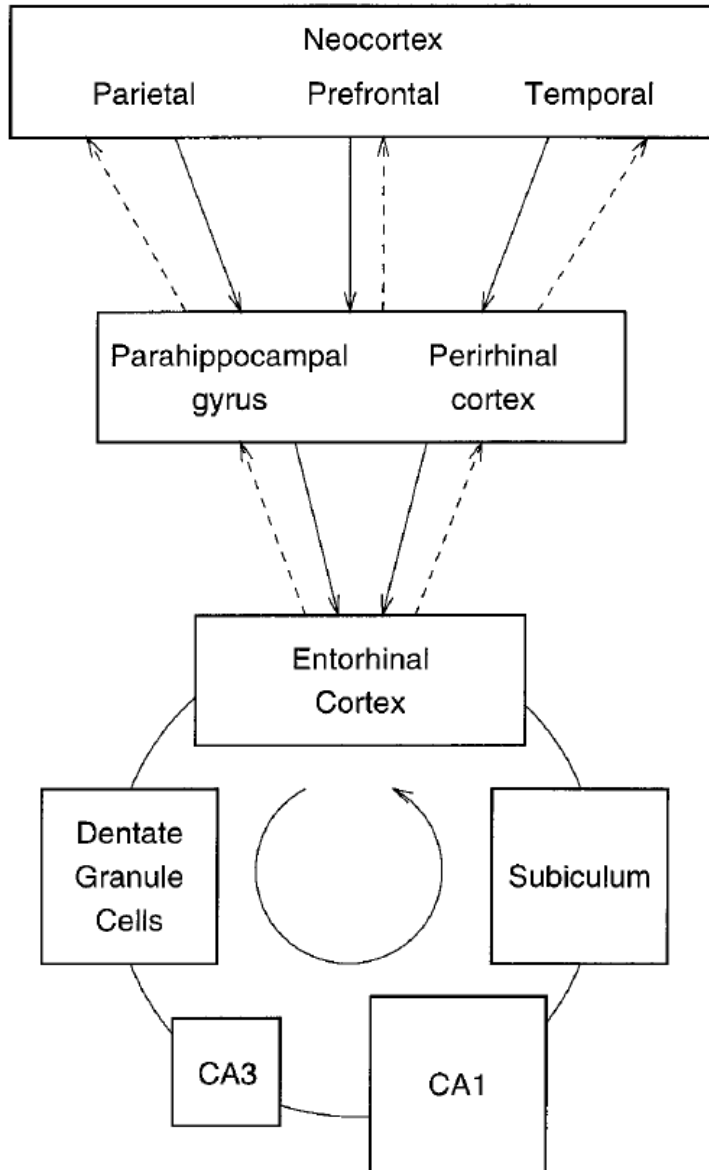

Rolls (2000)

CA1 cells are very sensitive to hypoxia

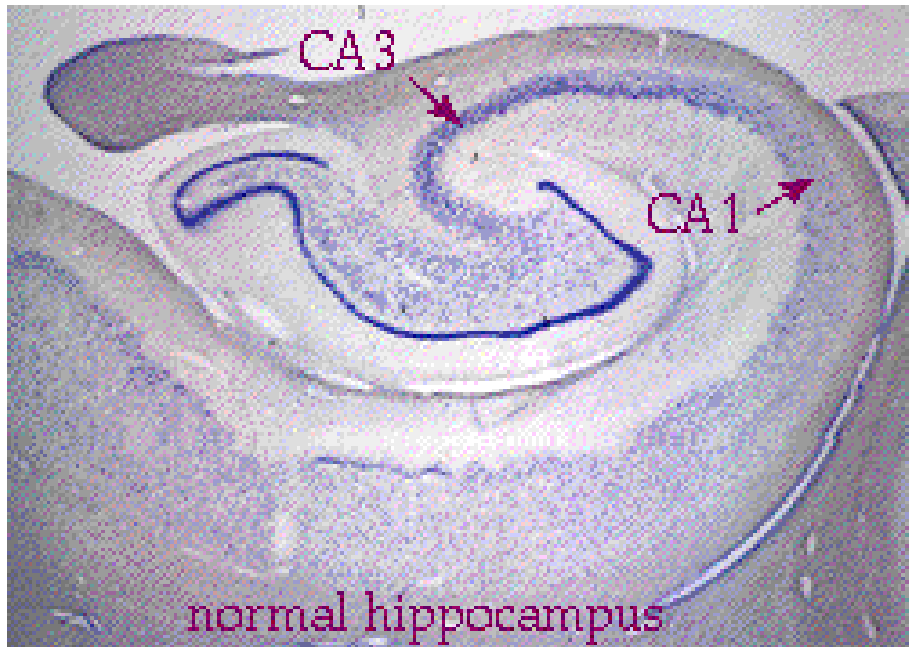

normal

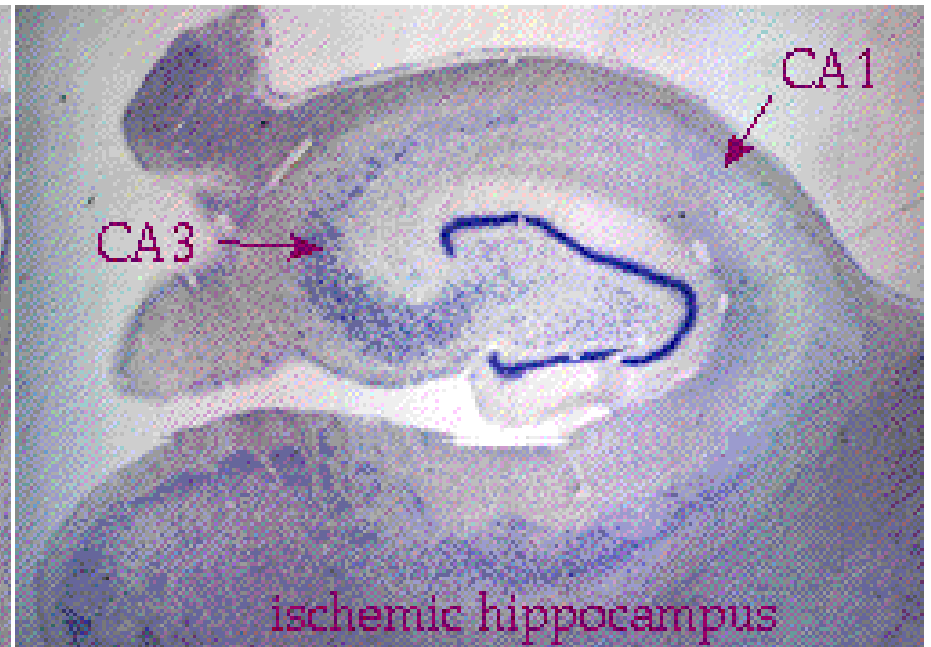

ischaemic

Patient N.A.: fencing foil (up nostril) to diencephalon

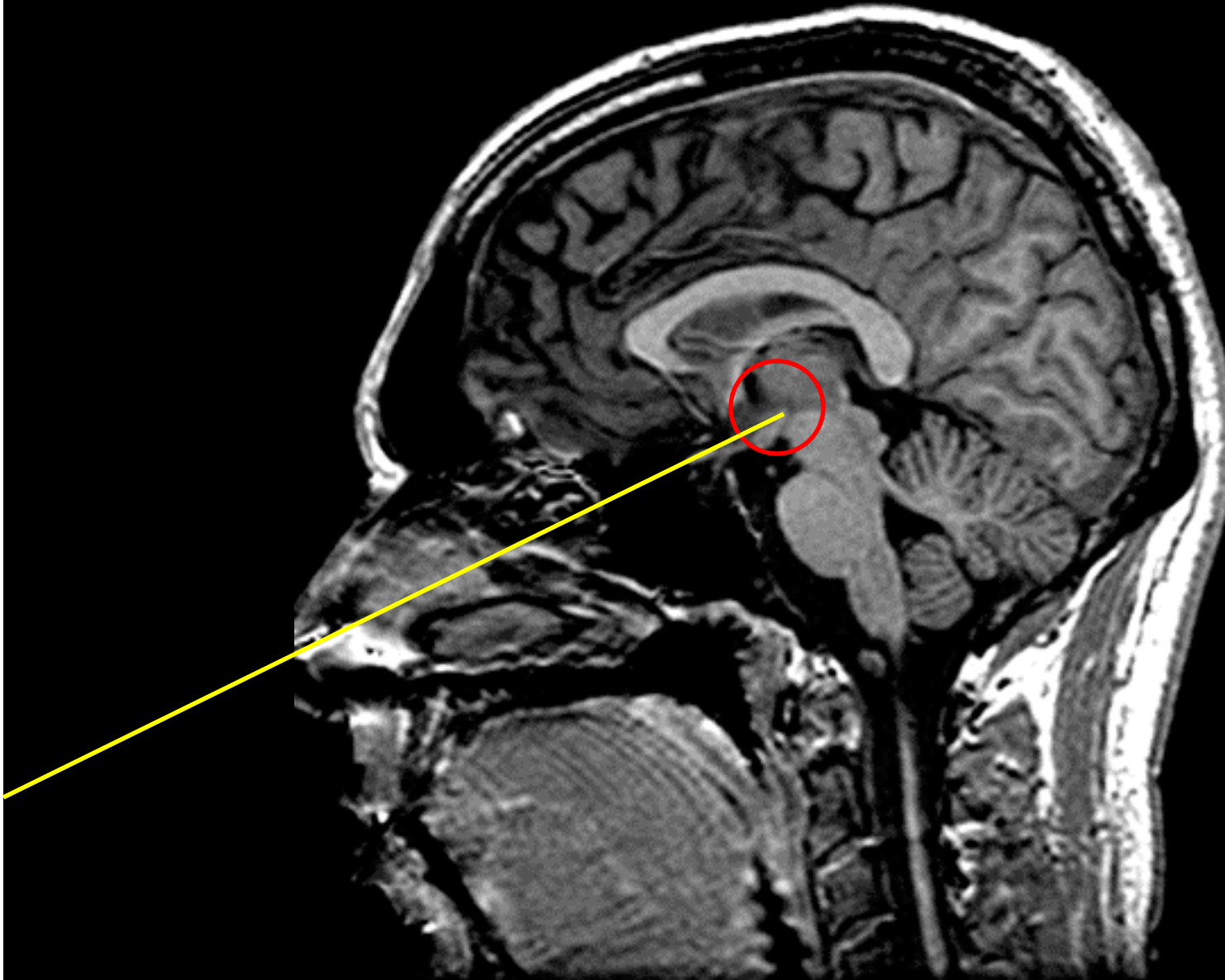

(Normal brain! Approximate area of damage in N.A. circled.)

Diencephalon: thalamus, hypothalamus, epithalamus



The Delay–Brion circuit: hippocampus → fornix → mammillary bodies →
mammillothalamic tract → thalamus

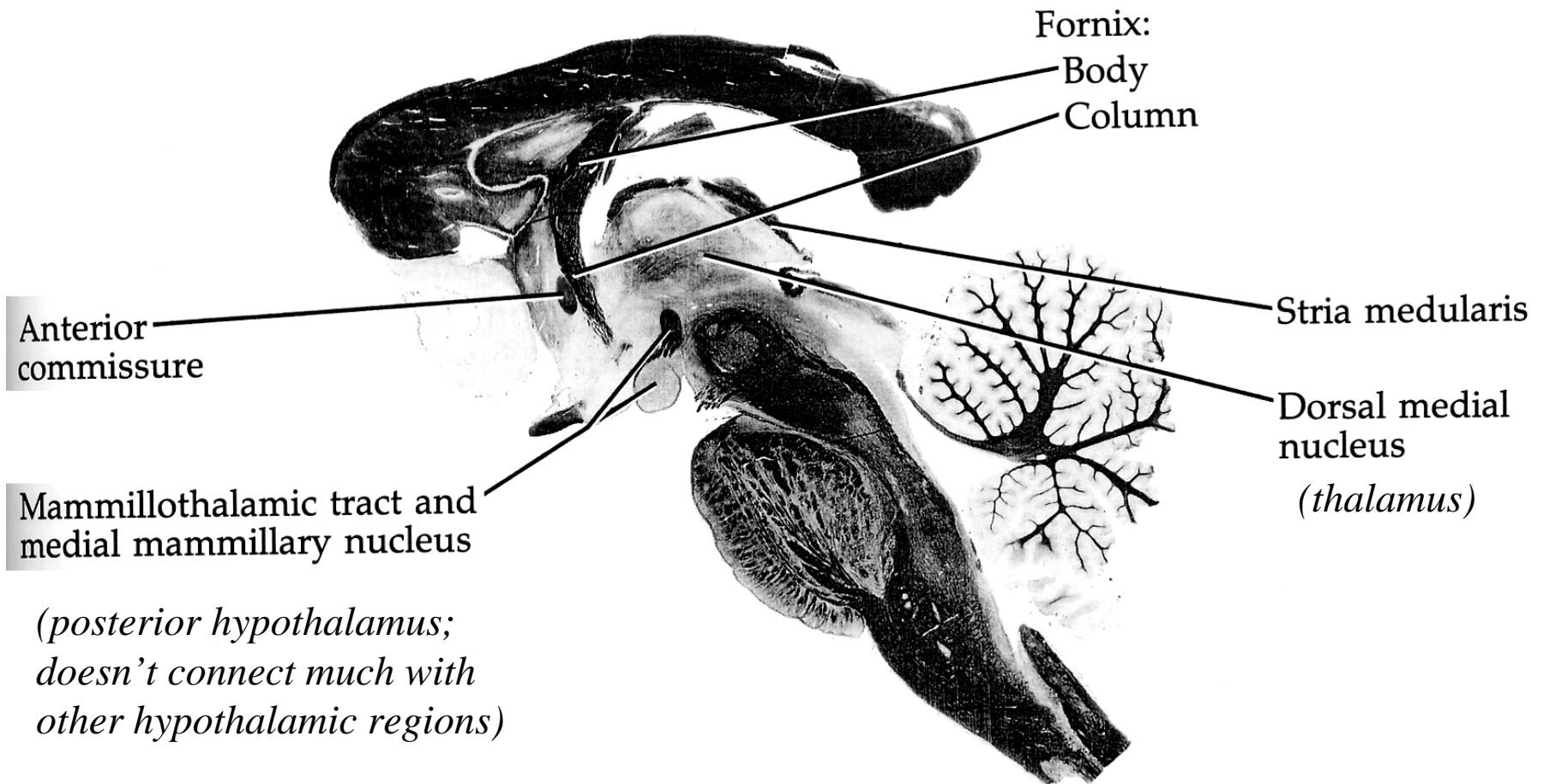

(myelin stain; from Martin, 1991)

*Defining the contribution of
medial temporal lobe structures*

Delayed non-matching to sample

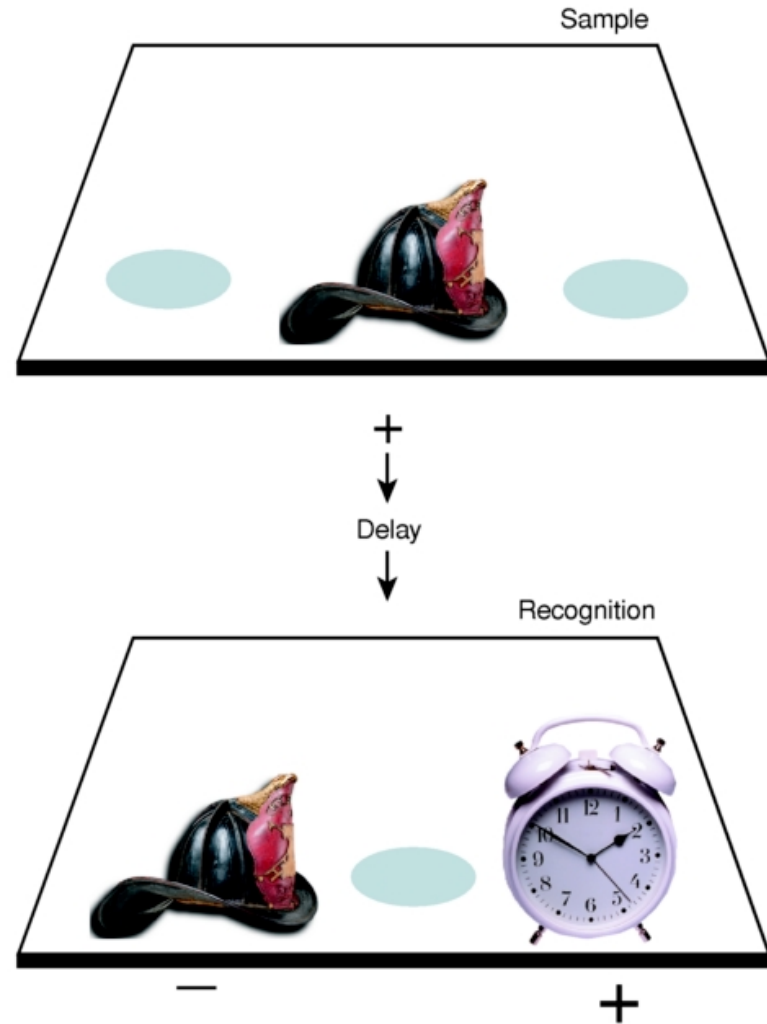
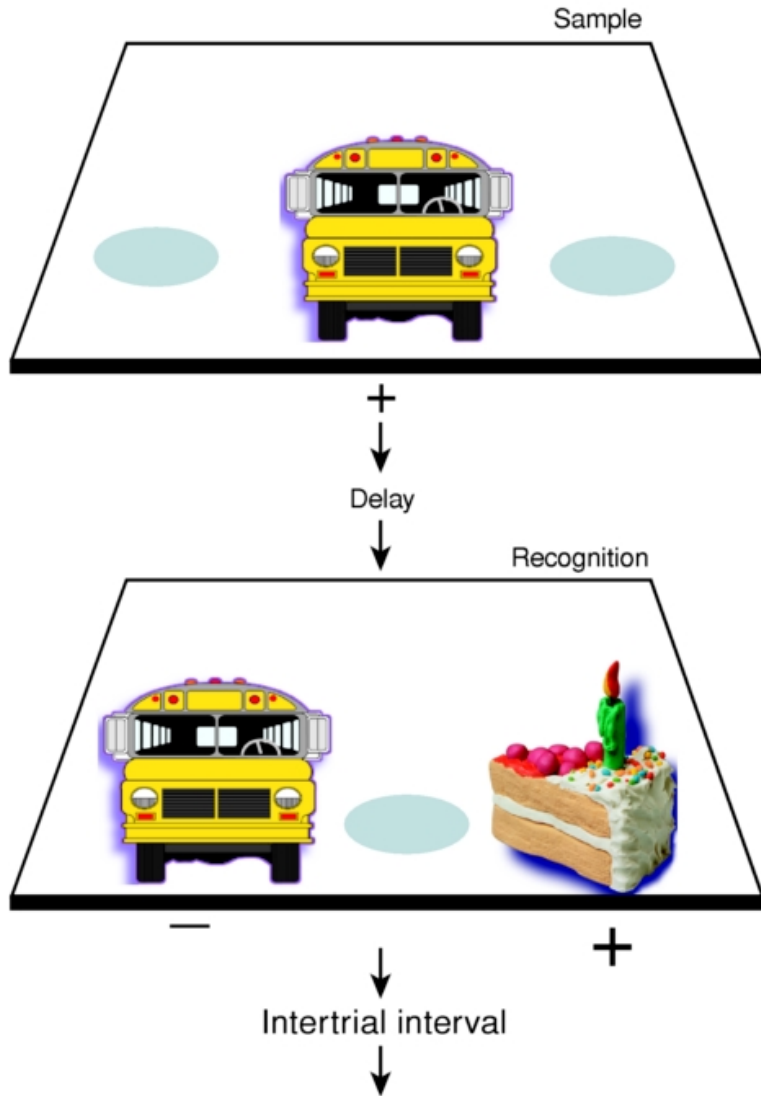

(from Zigmond et al., 1999)

Medial temporal lobe lesions and DNMTS (1): aspirative

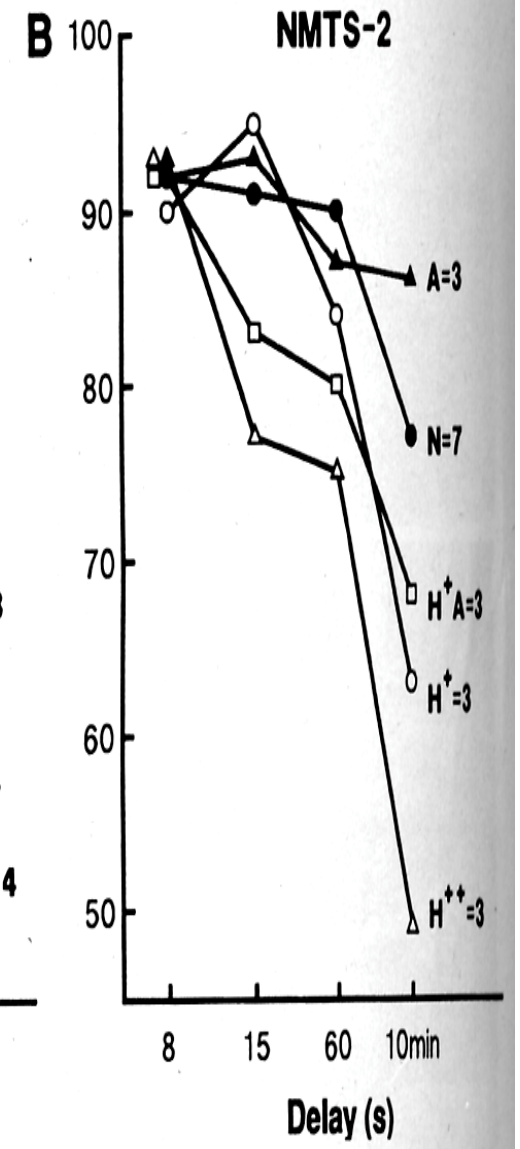
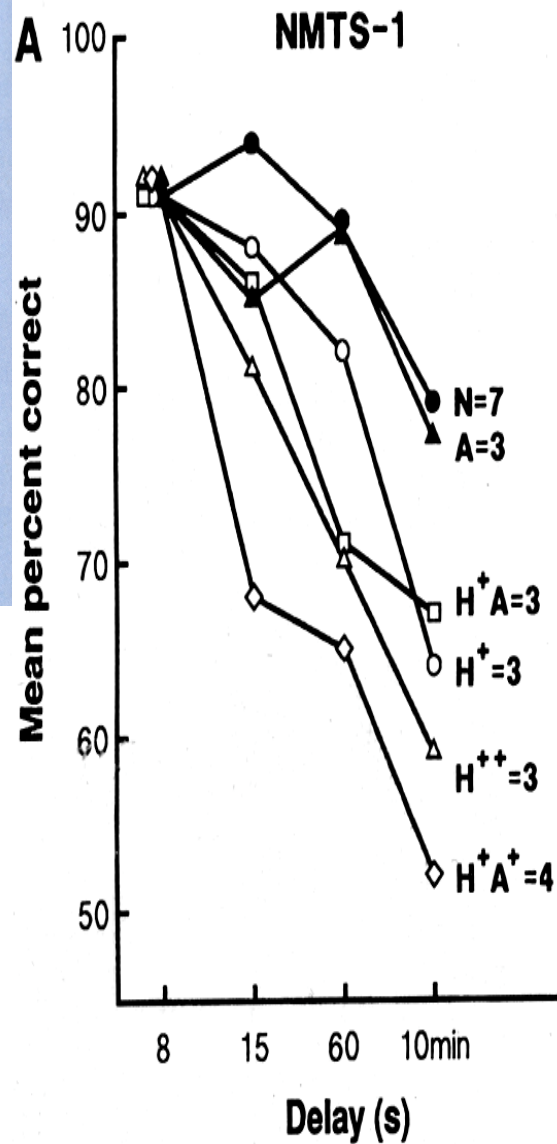
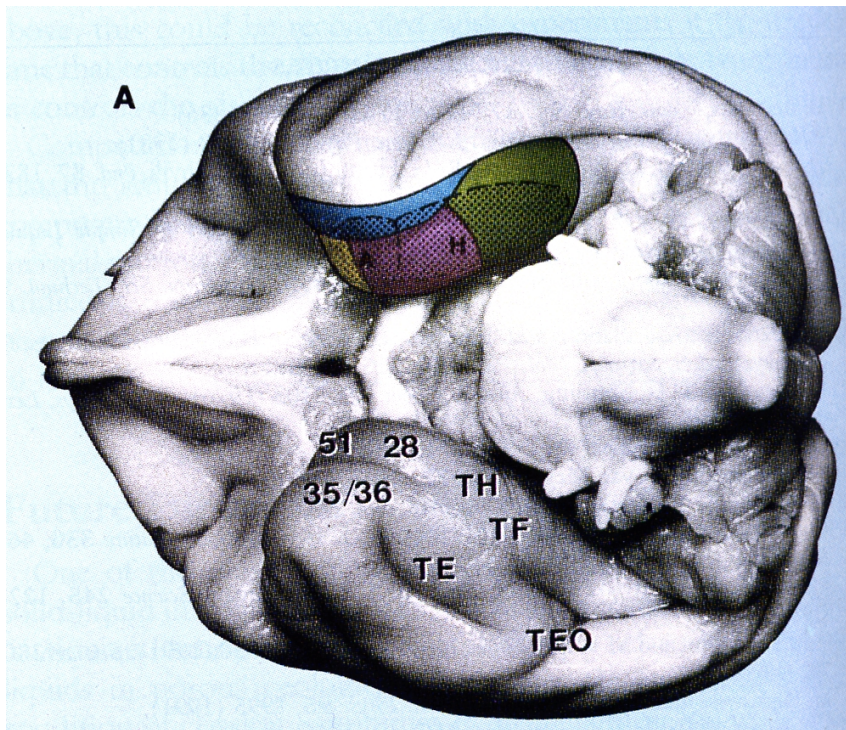

from Squire & Zola-Morgan (1991)

Medial temporal lobe lesions and DNMTS (2): excitotoxic

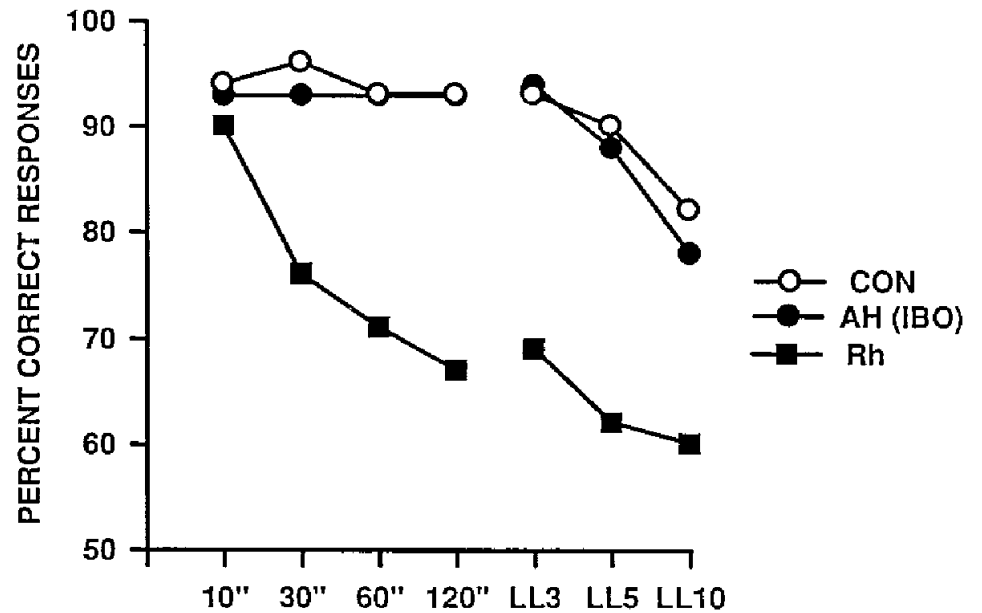
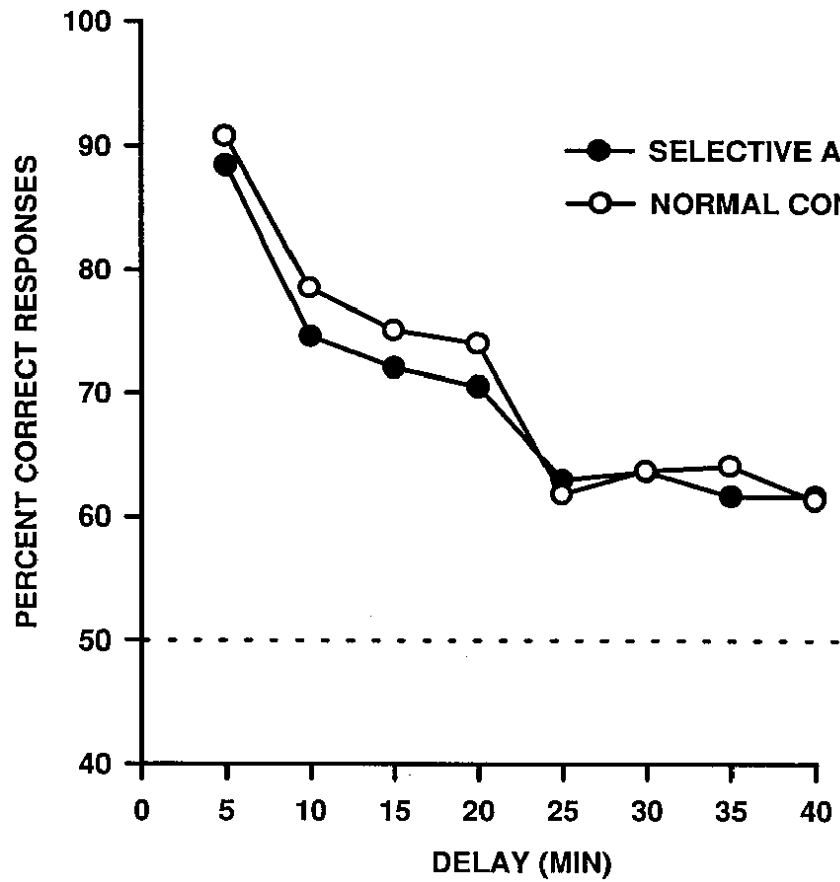

Murray & Mishkin (1998)

'Place cells' in the rat hippocampus

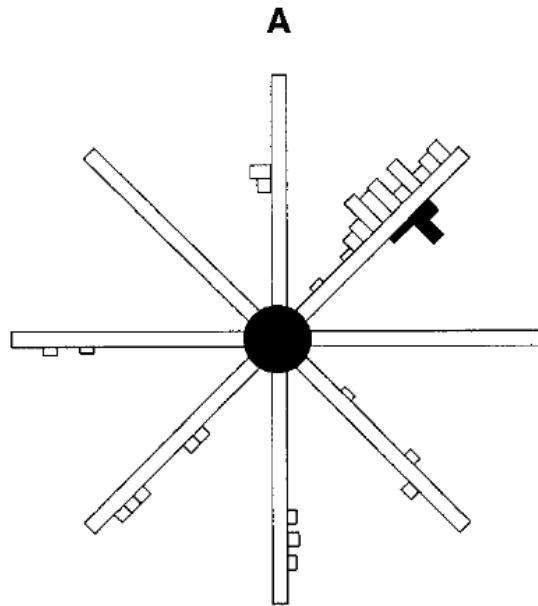

e.g. O'Keefe & Dostrovsky (1971)

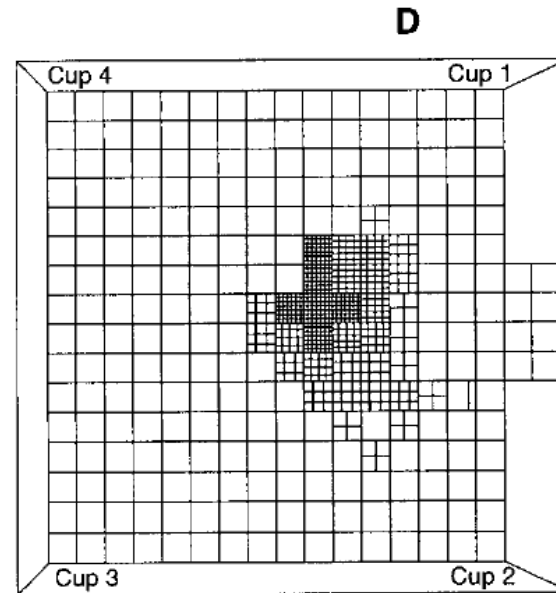
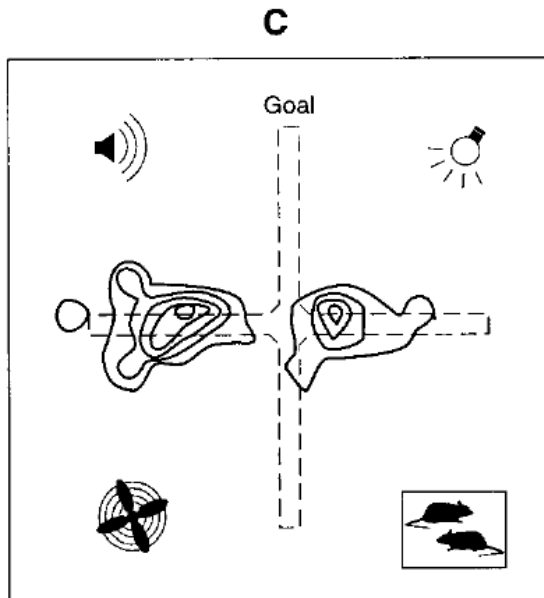

Place cells: the radial arm maze

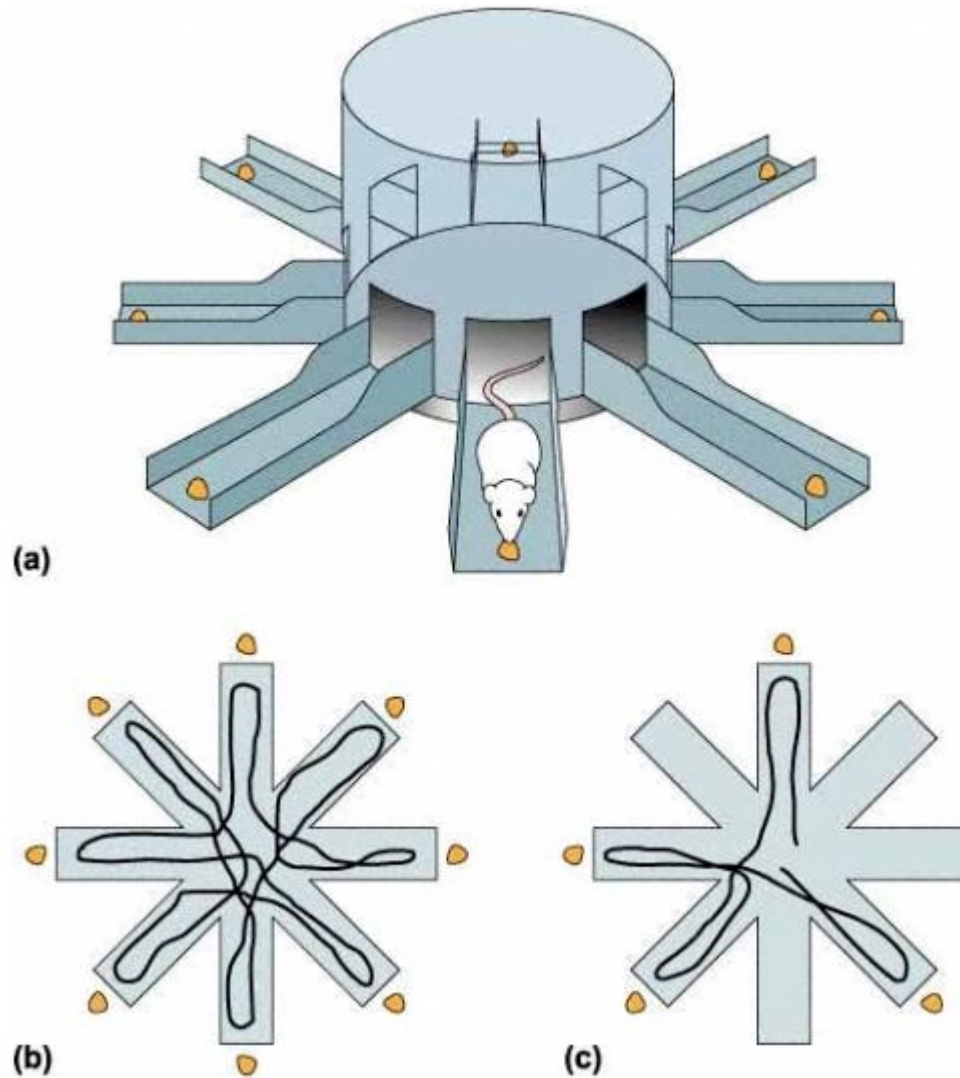

Olton et al. (1978). Hippocampal lesions impair versions of this task (Olton et al. 1979).

The hippocampus as a cognitive map?

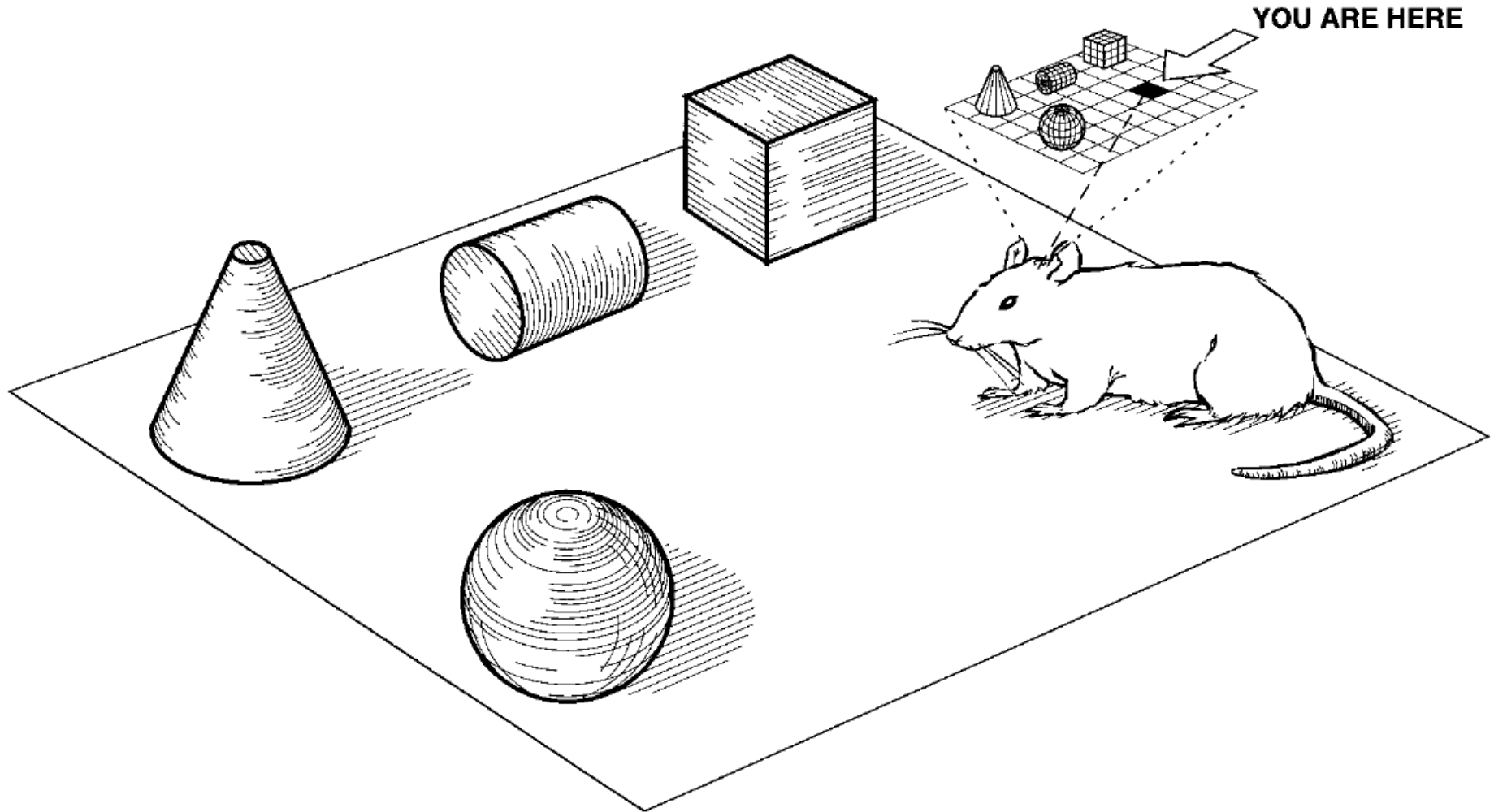
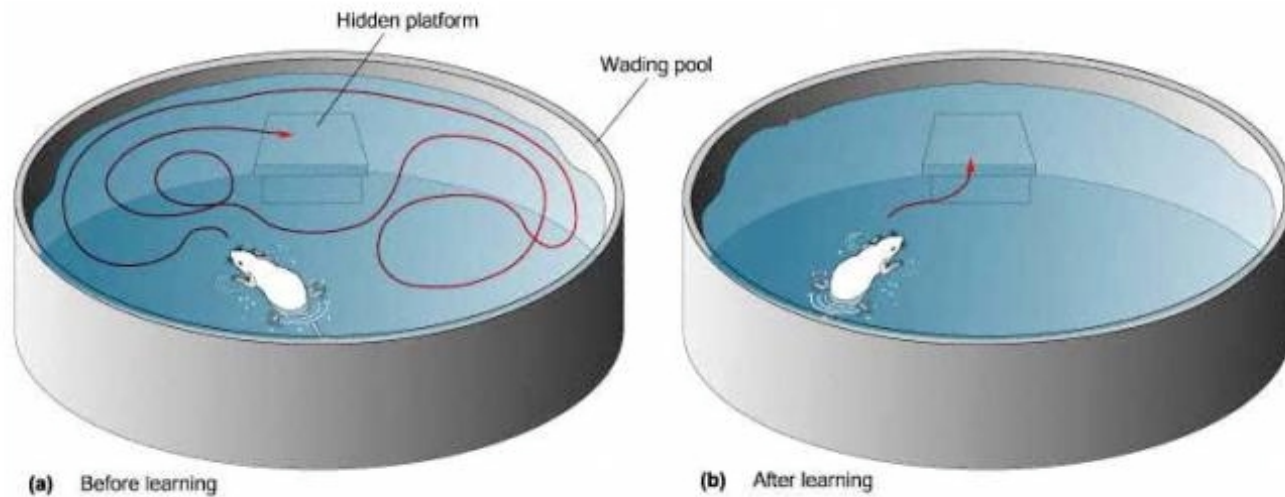

Figure 2. Cognitive Mapping

Conceptual model of hippocampal representation of a spatial environment according to the cognitive mapping hypothesis.

O'Keefe & Nadel (1978), after an idea by Tolman (1948)

Hippocampus and spatial navigation: Morris water maze (1)



Morris et al. (1982)

Hippocampus and spatial navigation: Morris water maze (2)

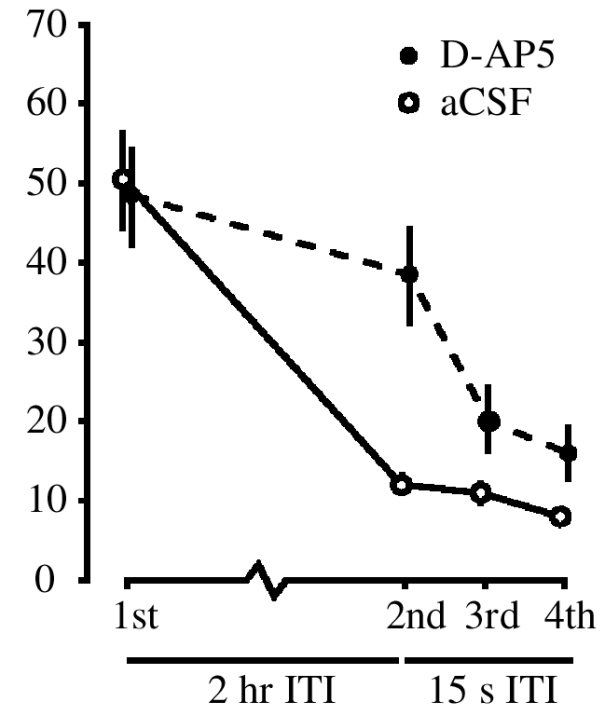
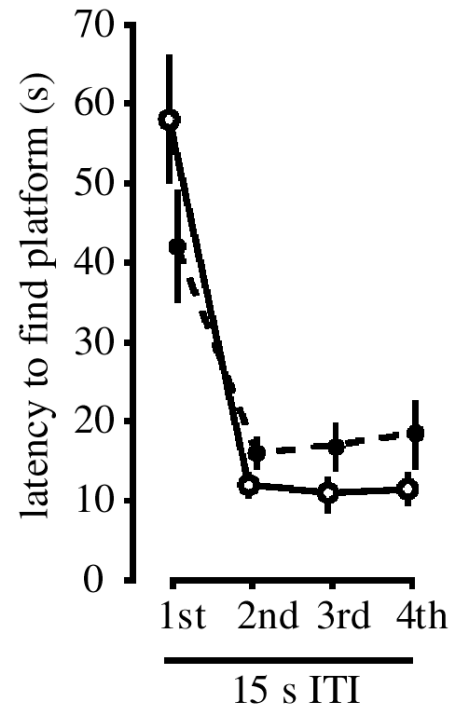
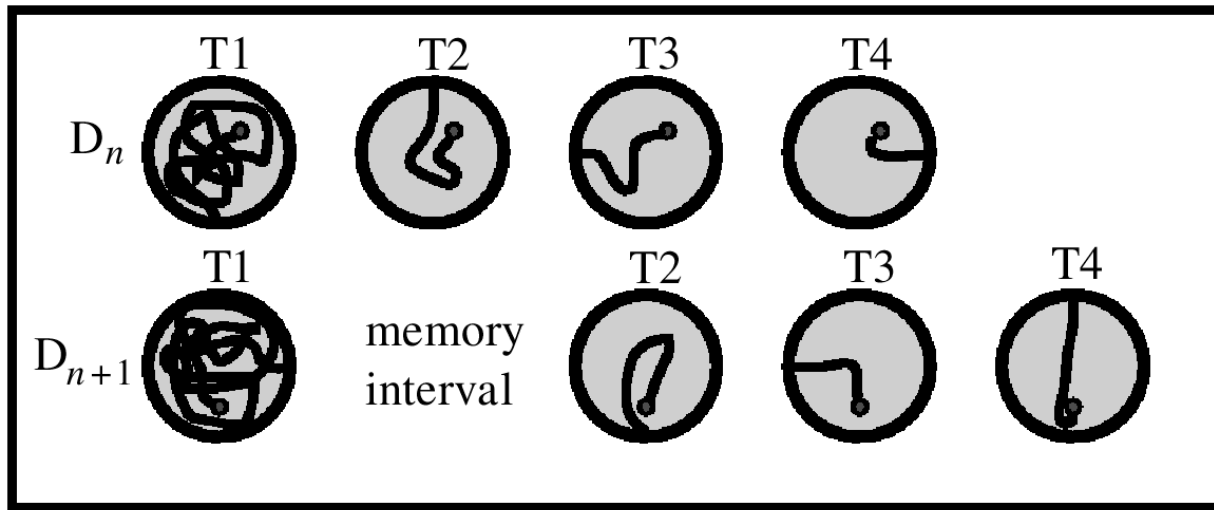

Morris et al. (1982); Morris & Frey (1997)

Hippocampus and spatial navigation: taxi drivers (1)

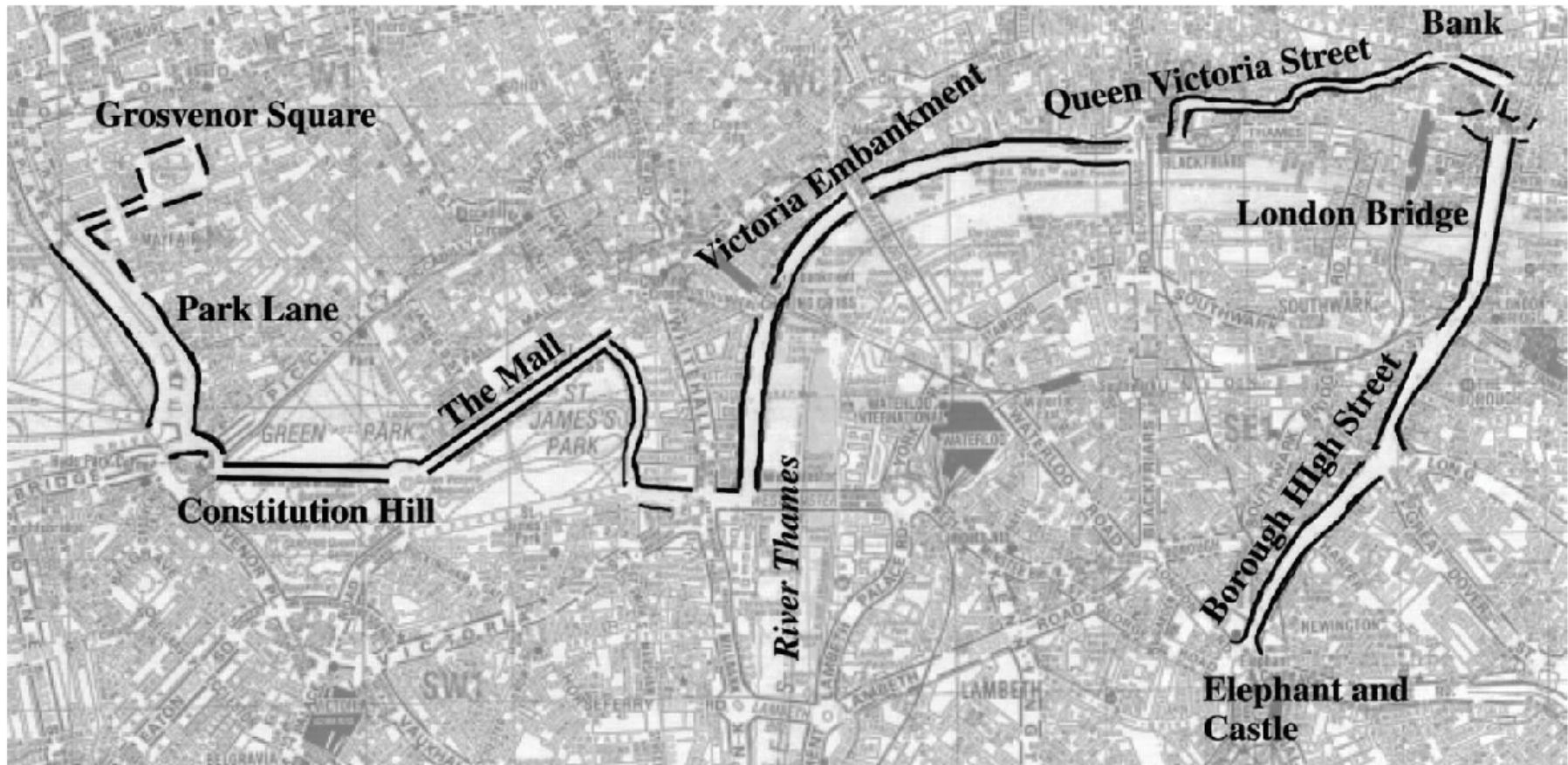
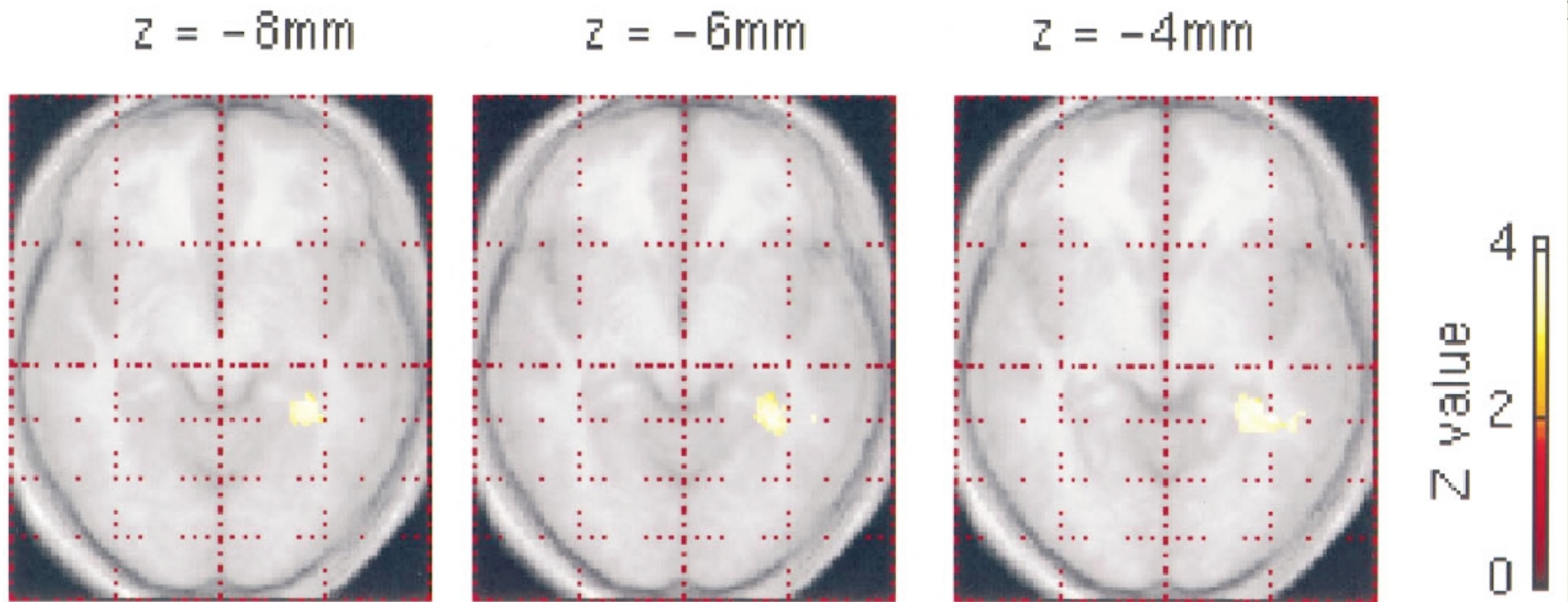

Figure 2. Map illustrating the complex route recalled by a taxi driver during a route scan. Subjects did not see any maps; they were blindfolded throughout. His speech output for this task follows: Pick up on Grosvenor Square in Mayfair, drop off at Bank Underground Station, then at the Oval Cricket Ground. . . “Grosvenor square, I’d leave that by Upper Grosvenor Street and turn left into Park Lane. I would eh enter Hyde Park Corner, a one-way system and turn second left into Constitution Hill. I’d enter Queen Victoria Memorial one-way system and eh leave by the Mall. Turn right Birdcage Walk, sorry right Horse Guards Parade, left Birdcage Walk, left forward Great George Street, forward into Parliament Square, forward Bridge Street. I would then go left into the eh the Victoria Embankment, forward the Victoria Embankment under the Blackfriars underpass and turn immediate left into Puddledock, right into Queen Victoria Street, left into Friday Street, right into Queen Victoria Street eh and drop the passenger at the Bank where I would then leave the Bank by Lombard Street, forward King William Street eh and forward London Bridge. I would cross the River Thames and London Bridge and go forward into Borough High Street. I would go down Borough High Street into Newington Causeway and then I would reach the Elephant and Castle where I would go around the one-way system. . . .” (end of scan).

Maguire et al. (1997)

Hippocampus and spatial navigation: taxi drivers (2)



Route recall (versus recall of famous landmarks in unfamiliar cities, e.g. Statue of Liberty)

Maguire et al. (1997)

Hippocampus and spatial navigation: taxi drivers (3)

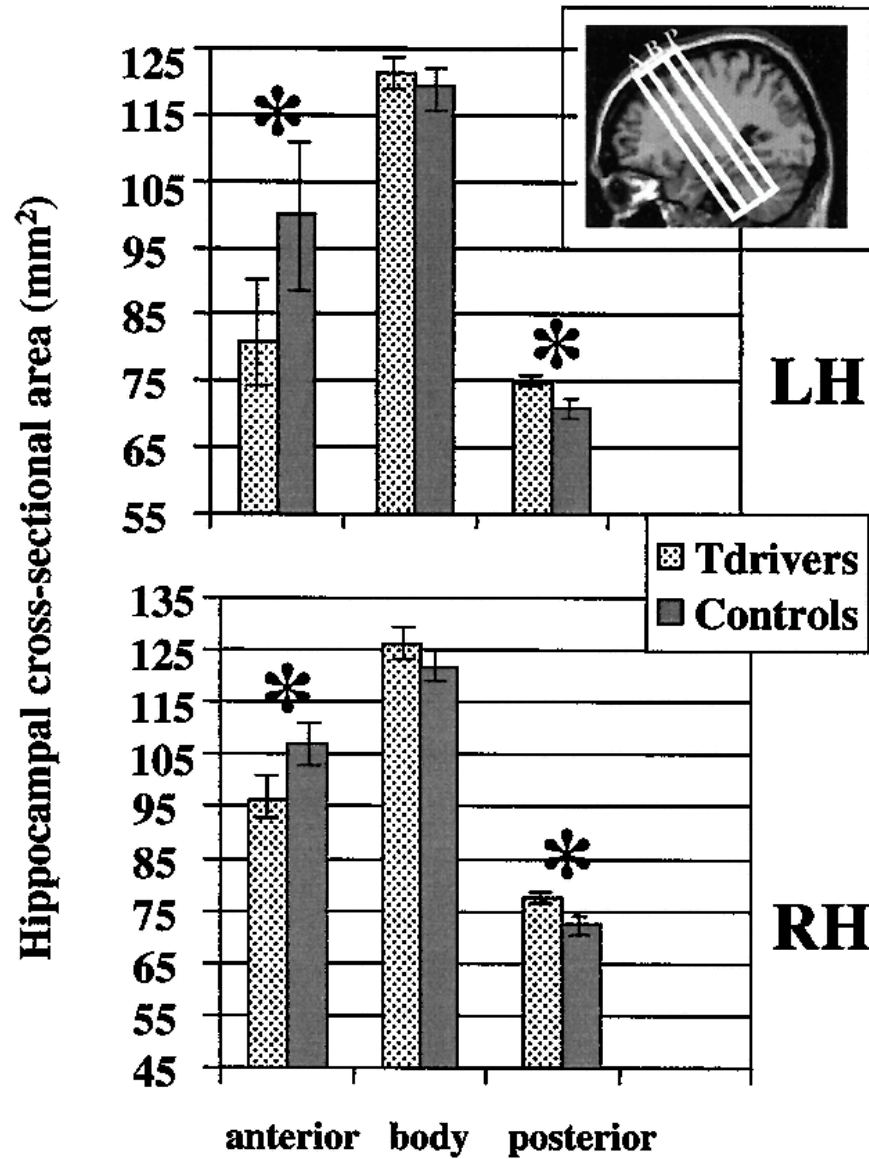

Hippocampus and spatial navigation: taxi drivers (4)

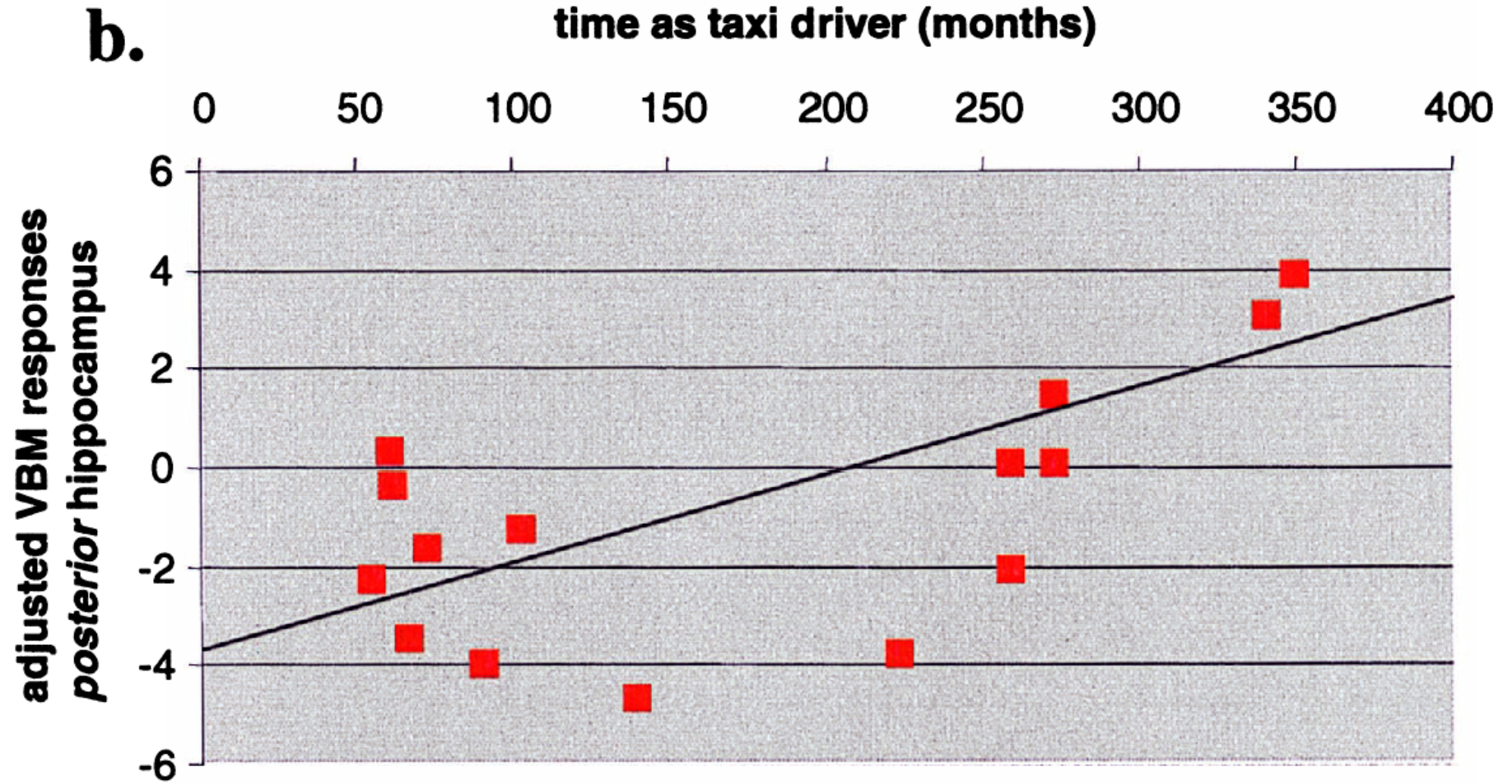

Hippocampus and spatial navigation: Duke Nukem

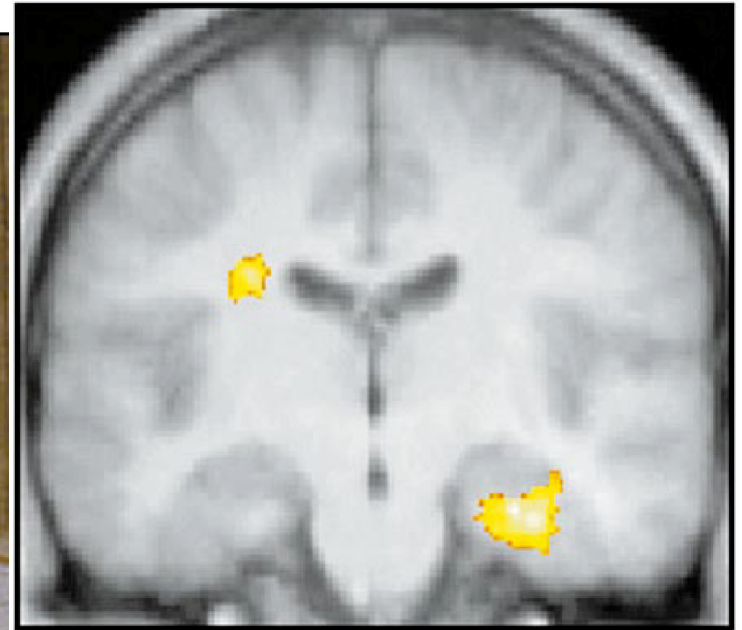

Navigation (versus following a trail of arrows)

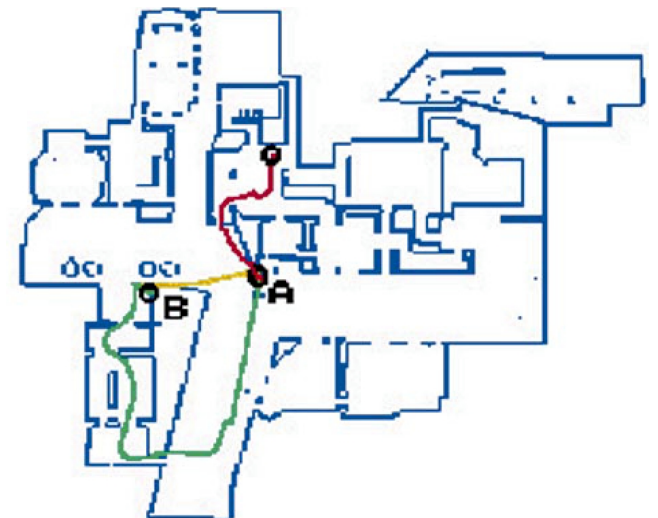

Maguire et al. (1998)

Hippocampus and scenes (1)

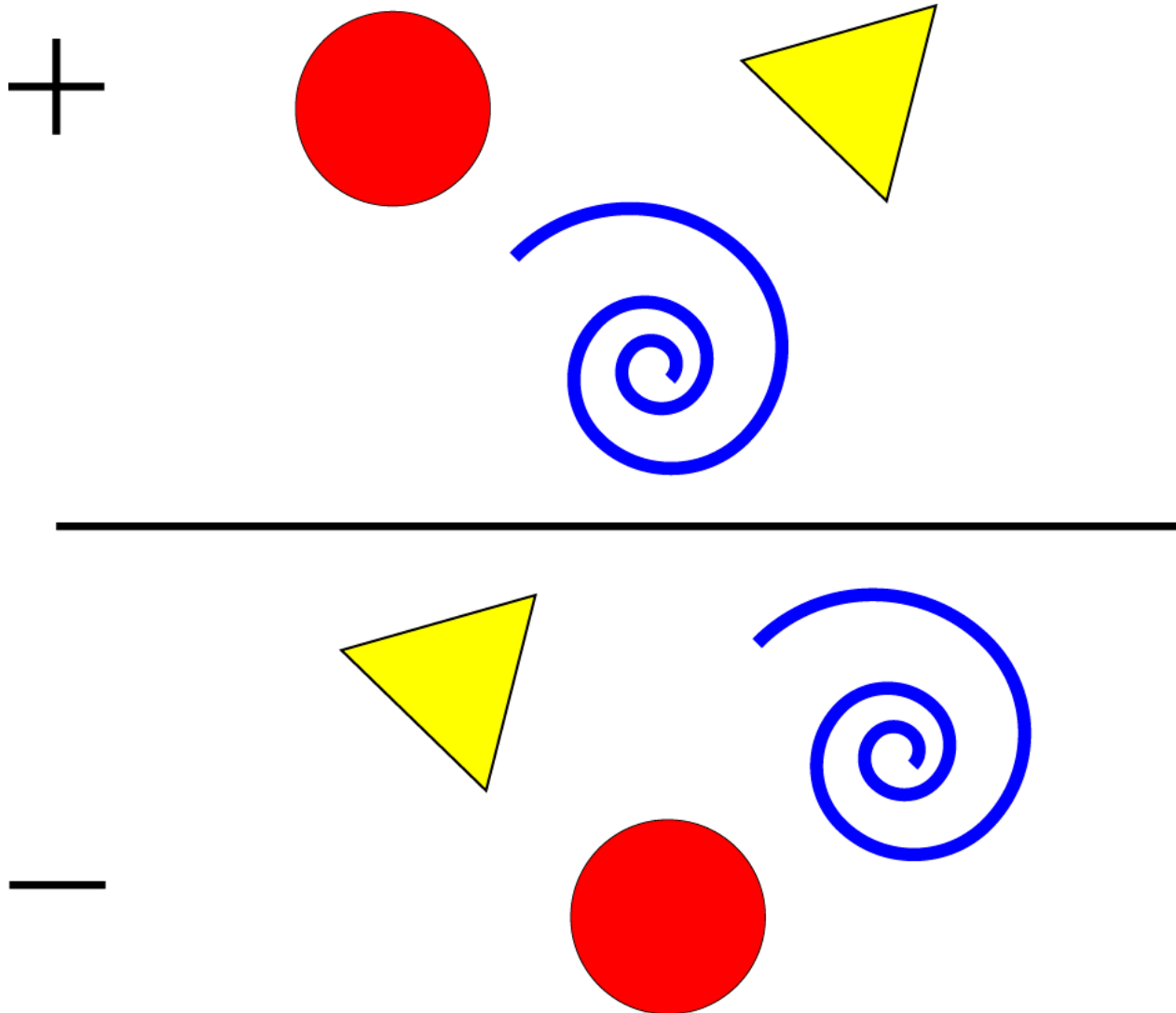

Gaffan & Harrison (1989)

Hippocampus and scenes (2)



*Speilberg (1981)
'Raiders of the
Lost Ark'*



Gaffan (1992)

'Relational coding' in the hippocampus (1): spatial

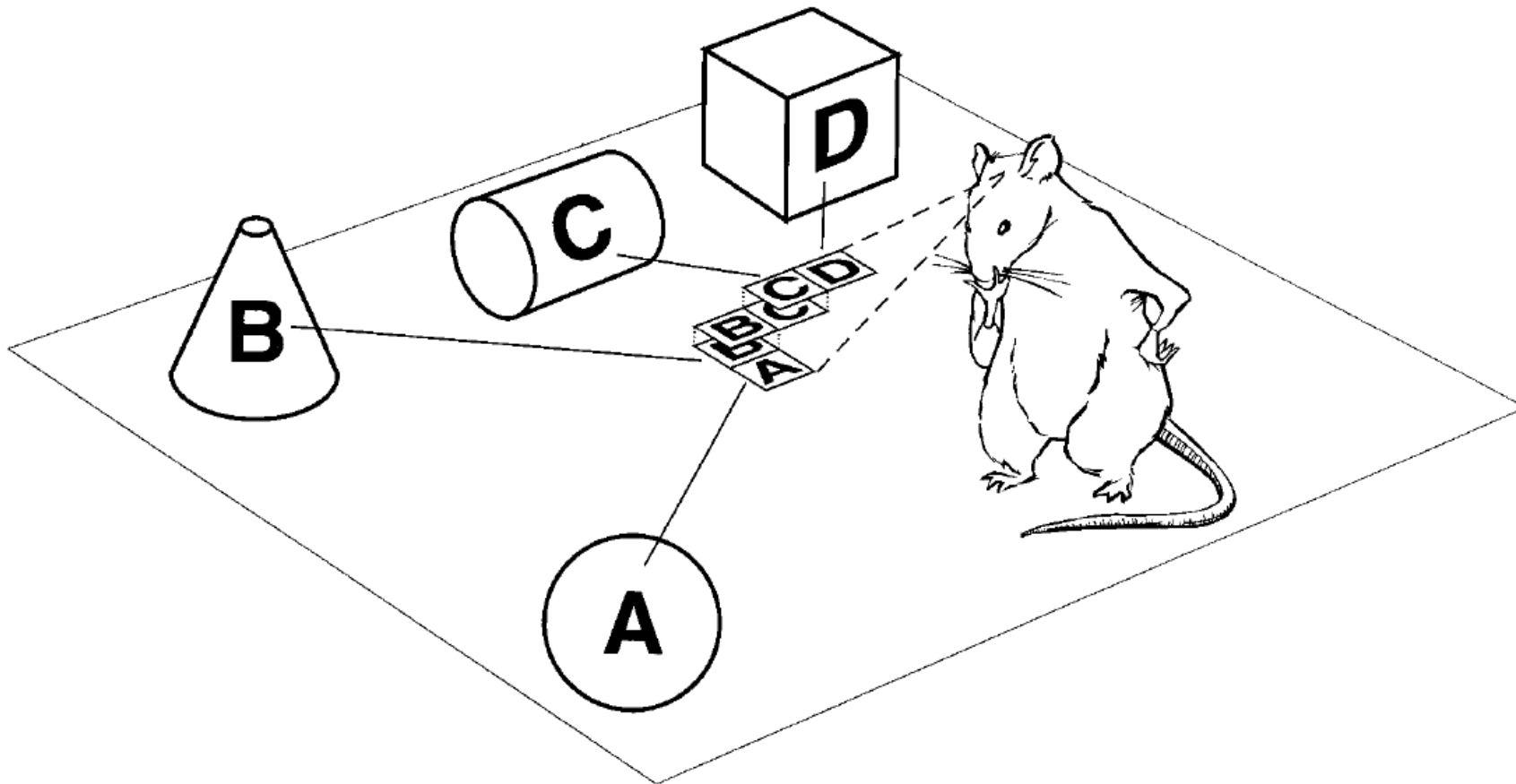

Figure 6. Relational Coding of Space

Representation of a spatial environment by cells that encode the spatial relations between a pair of the cues (AB, BD, or CD), plus nodal representations (dotted lines) for the cues that are common between some pairwise codings.

Eichenbaum et al. (1999)

'Relational coding' in the hippocampus (2): non-spatial

A>B>C>D>E

Train A>B, B>C, C>D, D>E.

Test A>E — easy (A always rewarded, E never).

Test B>D — hard (requires transitive inference).

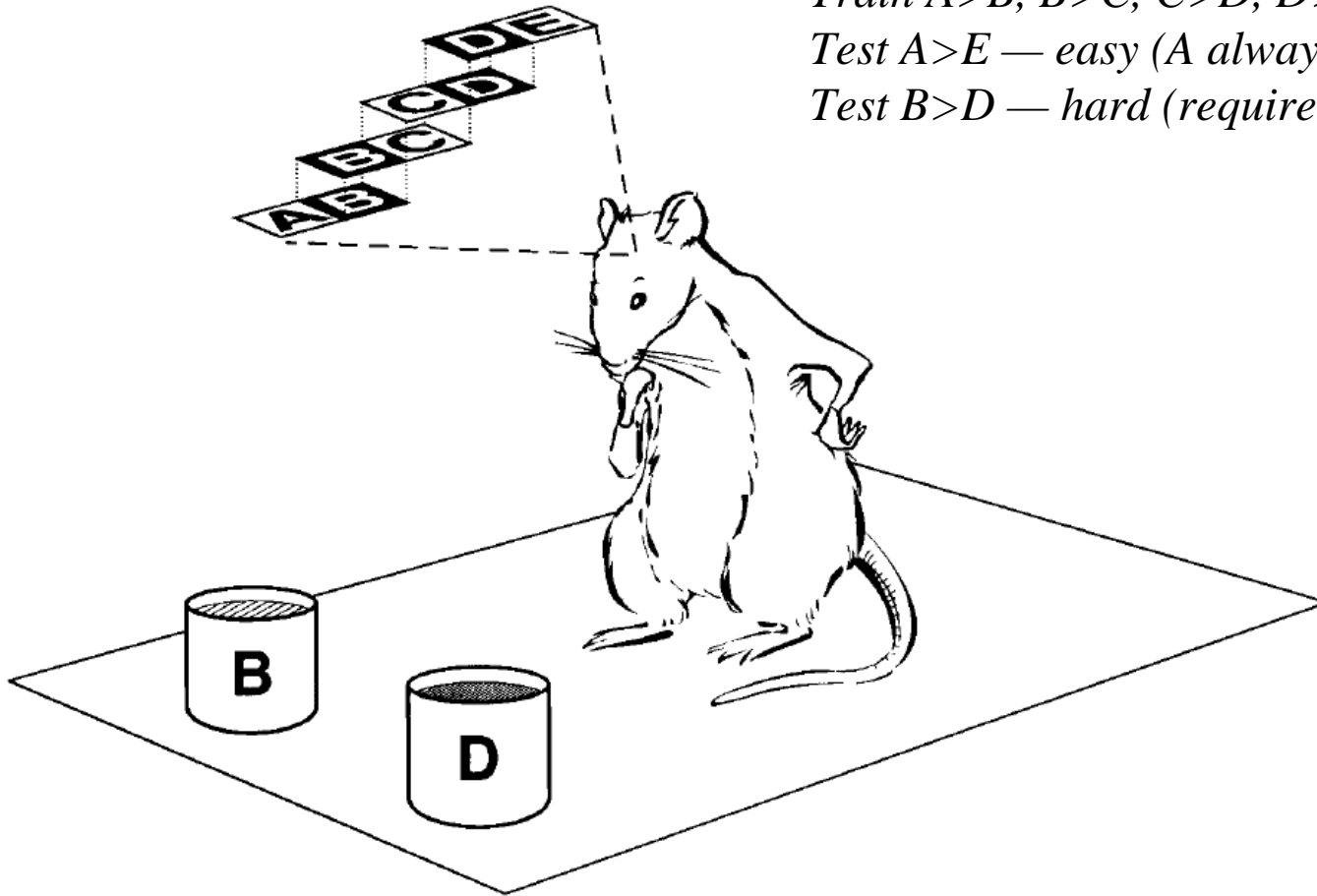
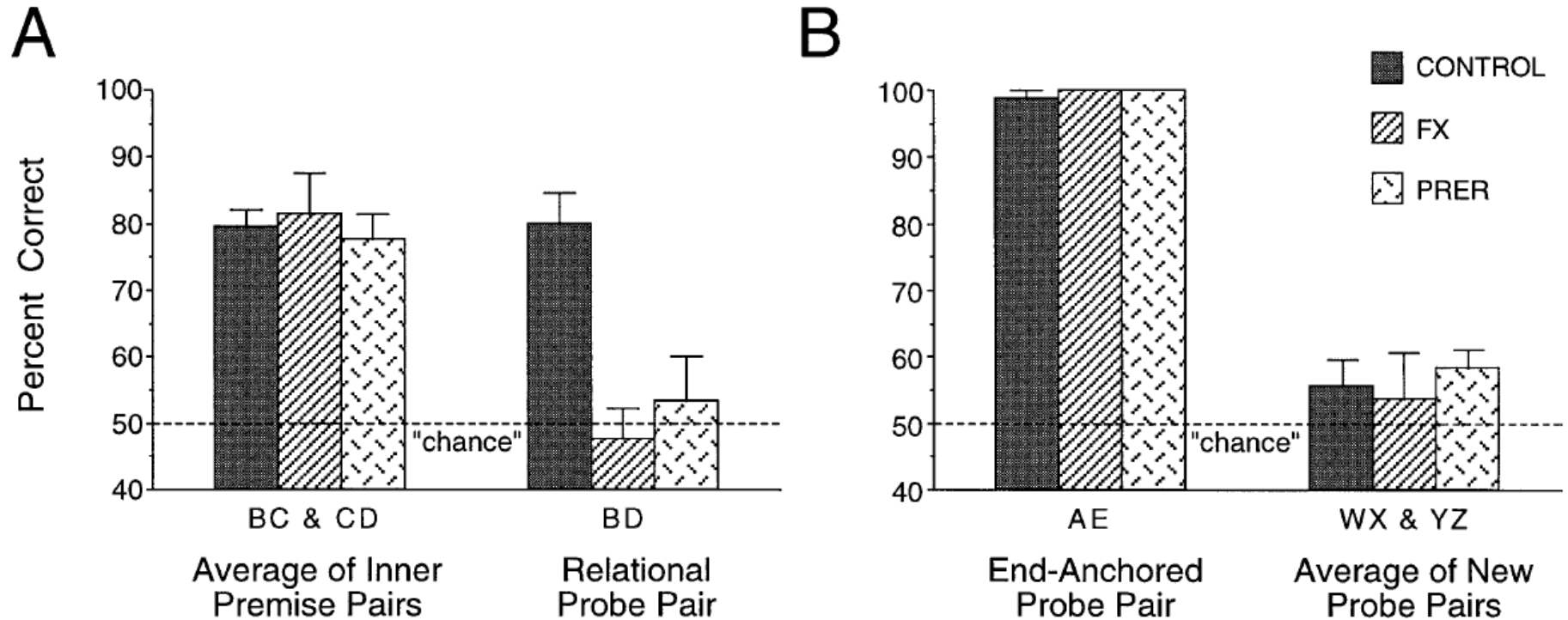

Figure 7. Transitive Inference in Serial Ordering

Representation of an odor series by cells that represent each trained odor pairing, plus nodal representations (dotted lines) of odors that are common between some of the trained pairings.

Eichenbaum et al. (1999)

'Relational coding' in the hippocampus (3): non-spatial



FX = fornix transection

PRER = perirhinal/entorhinal lesion

